

**GSFCAR PARTS**

**2005**

**quality parts and accessories for**

**aircooled  
volkswagen  
beetles and vans**

**UP TO  
70%  
OFF MRP**

December 2004

[www.gsfcarparts.com](http://www.gsfcarparts.com)



# a few words...

Welcome to the new GSF Air-Cooled Brochure for 2005. We hope that you find the new layout easy to use. We have included some new lines and are working on others from your comments received. As ever, our prices are competitive. I must comment on pricing here: the pound sterling has fallen in value against the Euro and risen in value against the US Dollar; unfortunately most of our product comes from Europe and therefore there are more price increases than price reductions. In addition base materials and energy, especially steel has endured huge increases during the last year and we are continually having price increases from our suppliers, some are reflected in this brochure and some will change during the life of this brochure. Please accept that this is likely to happen.

From humble beginnings, GSF has continued to grow, and we now have two major distribution centres located at Heathrow and Birmingham, plus a network of 42 branches nationwide. We offer mail order, secure Internet shopping plus a cash and carry service at our branches. New Branches opened in the last year are Derby, Leicester, Chadwell Heath and Worthing. We will also be opening in Cheltenham in the New Year.

It has been said that GSF is losing interest in, or stopping Air-Cooled parts; let me unequivocally refute that, I still own and drive a Beetle! We are aware that we need to improve our range and during the life of this brochure we shall do so, some new items are now in stock. Our business philosophy is to give you excellent service, great prices, and a choice of ways to buy. We are not always perfect and please tell us when we fail.

Thank you to customers old and new for your support. We also thank our staff, now numbering over 500 Nationwide, many of whom have been with us for a great number of years, the Air-Cooled people having in the main previously worked with "German & Swedish", "Autocavan" or and lastly (for those who remember) "Vee Wee" and it is you & they who have helped make GSF Car Parts as successful as we are.

Stan West  
Founder – GSF Car Parts

a few words...

## stocking policy

We sell parts that are generally known as replacement parts. These can be:

1. Manufactured by or on behalf of the car maker (common term "Genuine") and carry the car makers logo.
2. Manufactured by a supplier that supplies the car maker (common term "Original") and carry the manufacturers logo.
3. Manufactured by a supplier who does not supply the car maker.

## contacts

Mail Order t: 0208 917 3803

email: [aircooled@gsfcarparts.com](mailto:aircooled@gsfcarparts.com)

See pages 40-45 for information on your nearest branch or page 46 for information on how to mail order

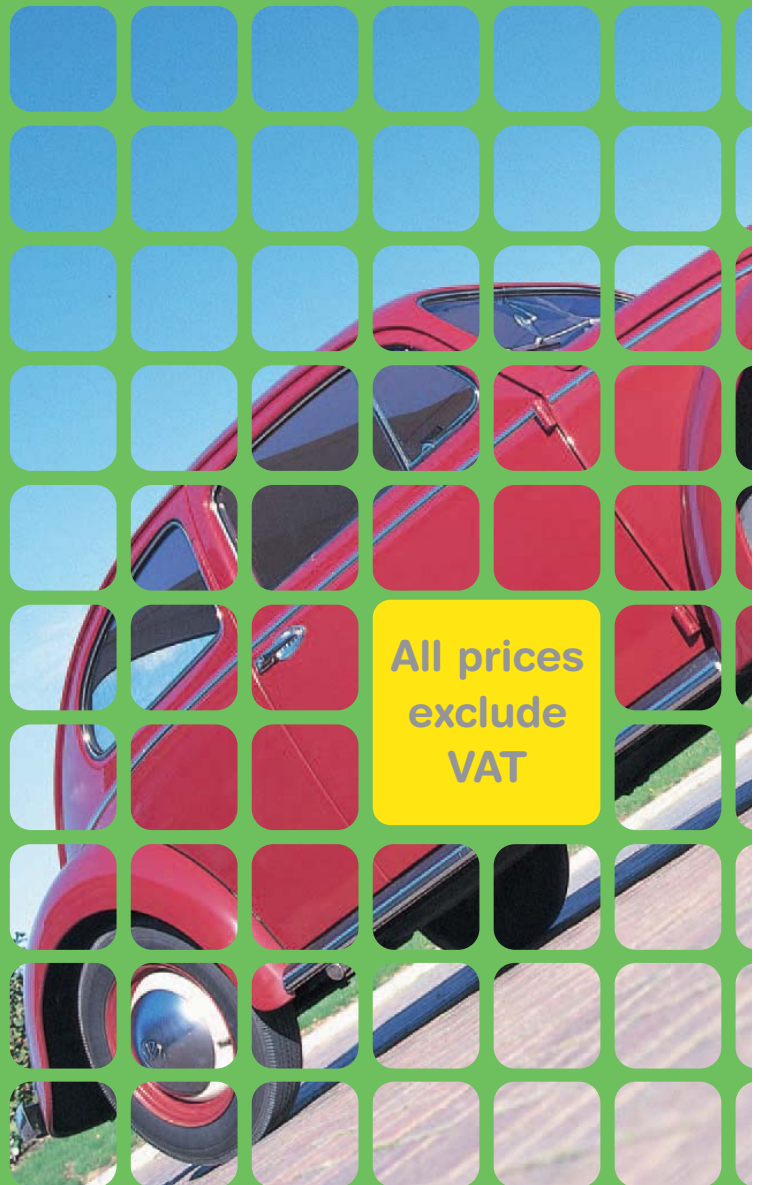

# contents

Accessories

31

Batteries

31

Body Panels

22-28

Body Trim

29-31



Brakes

16-18

Bumpers

20-21



Cables

19

Cal Look

36-37

Clutches

09

Electrical

34-35

Engine Parts

04-07

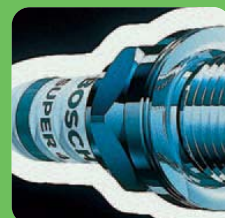

Exhausts

10-12

Fuel Systems

08

Ignition

33

Lighting

32

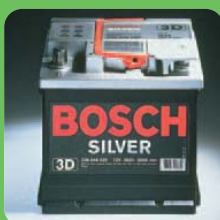

Maps

40-45

Spark Plugs

33

Suspension  
Steering  
13-15



Wheel  
Bearings

14

Wiper Blades

35



contents

# engine parts



## Engines

- VEGE-Europe's leading Engine Remanufacturer
- Guaranteed 12 months/unlimited mileage
- High Quality Remanufactured Unit
- All Engines sold on an exchange basis

Model	Engine	Year	Part No	Price
T1	1.2	67→	00020	£825.00
T1	1.3 Twin Port	70-79	00025	£835.00
T2	1.6 Twin Port	→75	00035	£825.00
T2	1.6 Twin Port	76-79	00040	£825.00
T25	2.0 CU	80-82	00042	£1,130.00



**VEGE**  
E N G I N E S

## Cylinder Heads

- Suitable for Unleaded Petrol

Model	Year	Single/Twin Port	Bare/Complete	Part No	Price
T1 1.2	65→	Single	Bare	01001	£105.00
T1 1.3	65→	Single	Bare	01001A	£105.00
T1 1.3	→79	Twin	Complete	Ex. 01002	£115.00
T1/T2 1.6	→79	Twin	Bare	01007	£56.00
T1/T2 1.6	→79	Twin	Complete	01008	£78.00
-Exhaust Studs				20280	£0.33

Ex = EXCHANGE



Single Port Cylinder Head



Twin Port Cylinder Head

## Gasket Sets

Kit contains

- Push Rod Tube Seals
- Valve Cover Gaskets
- Manifold Gaskets

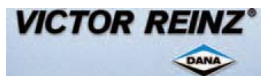

Model	Year	Part No	Price
T1 1.2 34 HP	63-79	11560	£6.50
T1/T2 1.3-1.6	→79	11561-Brazilian	£5.25
T1/T2 1.3-1.6	→79	11561A-German	£10.50
T2 1.7	→73	11562	£32.50
T2 1.8/2.0	→79	11563	£32.50
T25 2.0	79-82	11565	£32.50



1.3-1.6 Engine Gasket Sets

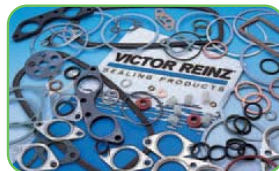

1.7-2.0 Engine Gasket Set

## Gaskets

Model	Year	Description	Part No	Price
T2 /T25 1.7-2.0	72-82	Valve Cover Gasket	11022	£0.65
T1 1.2-1.6	→79	Oil Change Kit	11610	£0.50
T2/T25 1.7-2.0	72-82	Oil Change Kit	11611	£1.30
T1/T2 1.3-1.6	71-79	Manifold Seal	18320	£1.00
T1/T2 1.3-1.6	71-79	Manifold Seal-Silicone	18321	£2.00
T1/T2 1.2-1.6	→79	Exhaust Flange	20170	£0.60
T1/T2 1.3-1.6		Twin Port Inlet Manifold	20180	£0.70



Manifold Sleeve



Exhaust Manifold



1.2-1.6 Oil Change Kit

## Crankcase - Type AS41

Model	Year	Description	Part No	Price
T1/T2 1.3-1.6	→79	Crankcase	01400	£210.00
T1/T2 1.2-1.6	→79	Crankcase adaptor-fits T2	99112	£14.00
T1/T2 1.3-1.6	→79	Stud Set	01410	£19.50
T1/T2 1.2-1.6	→79	Drain Cover	11630	£2.50
T1/T2 1.2-1.6	→79	Oil Strainer	12031	£2.50



Crankcase Stud Set



## Rocker Covers

Model	Year	Description	Part No	Price
T1/T2 1.2-1.6	63-79	Rocker Cover	10460	£3.75
T1/T2 1.2-1.6	63-79	Rocker Cover Clip	10465	£2.20
T1/T2 1.2-1.6	63-79	Rocker Cover Gasket	11021	£0.35



See pg 46 for details on how to order

## Piston & Barrel Sets

- Set of 4 Piston and Barrels complete with Piston Rings
- High quality to original specification

Model	Engine	Year	Piston Size	Part No	Price
T1	1.2 34HP	→69	77mm	16500	£150.00
T1	1.2	70-79	77mm	16501	£150.00
T1	1.3 Flat Top	→79	77mm	16502	£82.50
T1	1.5	67→	83mm	16504	£86.00
T1/T2 Mahle	1.6	→79	85.5mm	16505	£69.00
T1/T2 Cofap	1.6	→79	85.5mm	16505C	£69.00
T2/T25	2.0	→82	94mm	16510	£145.00

## Big Bore Piston & Barrel Sets

- Increase Engine size by fitting larger Pistons and Barrels - 1641 or 1679cc
- Approximately 10-20% more power

Model	Engine	Size	Description	Part No	Price
T1/T2	1.5/1.6	1641cc	Bolt On Forged Piston	16515A	£130.00
T1/T2	1.5/1.6	1641cc	Bolt On	16515B	£98.00
T1/T2	1.5/1.6	1641cc	Bolt On-Cofap	16515C	£98.00
T1/T2	1.5/1.6	1679cc	Bolt On	16515D	£165.00
T1/T2	1.6	1776cc	Machining required	16515E	£145.00
T1/T2	1.6	1835cc	Machining required	16515G	£160.00
T1/T2	1.6	1915cc	Machining required	16515H	£160.00



**MAHLE ORIGINAL**

## Piston Rings - Set of 4

Model	Engine	Year	Piston Size	Part No	Price
T1	1.2	71	77mm	16520	£15.75
T1	1.2/1.3	71	77mm	16521	£15.75
T1	1.5	69	83mm	16522	£15.75
T1/T2	1.6	79	85.5mm	16523	£15.75
T2/T25	2.0	82	94mm	16525	£19.50



**MAHLE ORIGINAL**

## Crankshafts

- Available for 1.3-1.6
- Reground or New
- Exchange Units



Model	Engine	Year	Description	Part No	Price
T1/T2	1.3-1.6	79	New Crankshaft	02099	£79.50
T1/T2	1.3-1.6	79	Regrind Crankshaft	02100	£52.00
T1/T2	1.2-1.6	79	Crankshaft Pulley	02300	£9.00
T1/T2	1.2-1.6	79	Timing Gear	02330	£8.50
T1/T2	1.2-1.6	79	Dist. Drive Gear	02340	£8.50
T1/T2	1.2-1.6	79	Crankshaft Oil Seal	11724	£2.00
T1/T2	1.2-1.6	79	Crankshaft Oil Seal Silicone	11724B	£3.50
T2/T25	1.7-2.0	82	Rear Crankshaft Seal	11726	£5.25
T2/T25	1.7-2.0	82	Front Crankshaft Seal	11729	£3.15
T1/T2	1.2-1.6	68-72	Shim 0.24/.30/.32/.34mm	02220	£0.80



Crankshaft Pulley 1.2-1.6



Dist Drive



Timing Gear

## Camshafts

Model	Engine	Year	Part No	Price
T1/T2	1.2-1.6 (3 Stud)	70	02400	£36.00
T1/T2	1.3-1.6 (4 Stud)	71-79	02401	£36.00
T1/T2	1.2-1.6 Cam Follower	79	14530	£2.80
T2	1.7-2.0 Cam Follower	79	14532	£8.00
T25	1.6-2.0 Cam Follower	80-82	14534	£10.75

## Conrods

Model	Engine	Year	Description	Part No	Price
T1/T2	1.3-1.6	79	Con Rod Set	02452	£75.00
T1/T2	1.3-1.6	79	Bushes	16165	£1.50



## Engine Bearings

- Bearings come in complete sets to fit engines from 1963



Model	Engine	Description	Size	Part No	Price
T1/T2	1.2-1.6	Mains	STD	16130	£19.50
T1/T2	1.2-1.6	Mains	+0.25mm	16131	£19.50
T1/T2	1.2-1.6	Mains	+0.50mm	16132	£19.50
T1/T2	1.2-1.6	Mains	+0.75mm	16133	£19.50
T2/T25	1.7-2.0	Mains	STD	16148	£28.00
T1/T2	1.2-1.6	Big End	STD	16170	£6.00
T1/T2	1.2-1.6	Big End	+0.25mm	16171	£6.00
T1/T2	1.2-1.6	Big End	+0.50mm	16172	£6.00
T1/T2	1.2-1.6	Big End	+0.75mm	16173	£6.00
T2/T25	2.0	Big End	STD	16178	£16.00
*OVERSIZE BEARINGS ARE LARGER ON THE CRANKSHAFT SIZE					
T1/T2	1.2-1.6	Camshaft	STD	16125	£4.75
T2/T25	1.7-2.0	Camshaft	STD	16126	£7.50

## Flywheel

Model	Year	Description	Part No	Price
T1/T2	1.5-1.6	Flywheel 200mm 12v	02200	£48.50
T1/T2	1.2-1.6	Gland Nut	02260	£5.50
T1/T2	1.2-1.6	Oil Seal - Flywheel	11724	£2.00
T1/T2	1.2-1.6	Oil Seal - Rubber Ring	11720	£0.90



Gland Nut



Flywheel Oil Seal



Flywheel - 200mm



## Engine Codes

Code	Engine	Model	From - To	BHP
B	1600	Type 2	8.67-7.70	47
D	1200	Type 2	5.59-8.65	34
		Type 1	8.65-	34
E	1300	Type 1	8.65-7.70	37
F	1300	Type 1	8.65-7.70	40
H	1500	Type 2	8.65-7.68	44
		Type 1	8.65-7.70	44
L	1500	Type 2	11.65-7.68	40
AB	1300	Type 1	8.70-7.73	44
AC	1300	Type 1	8.70-7.70	40
AD	1600	Type 1/2	8.70-7.73	50
AE	1600	Type 1	8.70-7.71	77
AF	1600	Type 1/2	8.70-1.80	46
AH	1600	Type 1	8.71-1.76	47
AJ	1600	Type 1	8.74-12.80	50
AK	1600	Type 1	8.72-7.73	47
AR	1300	Type 1	8.73-7.75	44
AS	1600	Type 1/2	8.73-7.79	50
CJ	2000	Type 2	8.75-7.79	70



## Oil Pumps

- Excellent Quality
- Check the depth of your Pump for correct application

Model	Year	Description	Part No	Price
T1/T2 1.2-1.6	⇒71	29mm Depth	15305	£11.50
T1/T2 1.2-1.6	71-79	33mm Depth	15306	£11.50



See pg 46 for details on how to order

## Push Rod/Tubes



1.3-1.6



1.7-2.0



Telescopic

Model	Year	Description	Part No	Price
T1/T2 1.3-1.6	⇒79	Pushrod	14555	£3.25
T1 1.2 34 Hp	63-79	-	14540	£1.50
T1/T2 1.3-1.6	⇒79	-	14541	£1.50
T2/T25 1.7-2.0	⇒82	-	14545	£3.50
T1/T2 1.2-1.6	⇒79	Telescopic-fits in situ	14547	£3.50
T1/T2 1.2-1.6	⇒79	Telescopic-fits in situ-Best Quality	14547A	£7.50

## Push Rod Tube Seals



Push Road Tube Seals 1.3-1.6



Push Road Tube Seals 1.7-2.0

Model	Year	Part No	Price
T1/T2 1.2-1.6	⇒79	14560	£0.25
T2/T25 1.7-2.0 Inner	⇒82	14563	£0.50
T2/T25 1.7-2.0 Outer	⇒82	14565	£0.50

## Inlet Valves



Valves & Collets



Valve Springs & Retainer

Model	Year	Size	Part No	Price
T1 1.2/1.3	⇒70	35.6mm	14300/1	£3.00
T1 1.3	71⇒	35.6mm	14305	£4.00
T1/T2 1.5	⇒70	35.6mm	14305	£4.00
T1/T2 1.6	⇒76	35.6mm	14305	£4.00
T2 1.7/1.8	⇒75	39.3mm	14308	£4.00
T25 2.0	80-82	39.3mm	14308	£4.00

## Exhaust Valves

Model	Year	Part No	Price
T1 1.2-1.3	63⇒	14400	£5.00
T1 1.3	⇒70	14400	£5.00
T1/T2 1.3-1.6	71-74	14401	£5.00
T1 1.5	67⇒	14401	£5.00
T2 1.6	⇒73	14401	£5.00
T2 1.6	73-74	14402	£5.00
T1 1.3-1.6	75-79	14403	£5.00
T2 1.6	75-79	14403	£5.00
T2 1.7/1.8	⇒73	14404	£5.00
T2/T25 2.0	76-82	14404	£5.00
T1/T2 1.2-1.6	Valve Spring	14450	£1.25
T1/T2 1.2-1.6	3 Groove Cotter	14468	£0.30
T1/T2 1.2-1.6	Valve Spring Retainer	14465	£0.70

## Valve Guides

Model	Engine	Year	Inlet/Exhaust	Part No	Price
T1/T2	1.2-1.6	⇒79	Inlet	14480	£3.50
T2	1.7-2.0	⇒79	Inlet	14483	£3.50
T1/T2	1.2-1.6	⇒79	Exhaust 8mm	14481	£3.50
T2	1.7-2.0	⇒82	Exhaust 9mm	14484	£3.50
T1/T2	1.2-1.6	⇒79	Tappet Screw	14488	£0.60
T1/T2	1.2-1.6	⇒79	Tappet Nut	14489	£0.15

## Oil Coolers



Oil Cooler 1.3-1.6 71-79



Oil Cooler 1.2⇒79; 1.3-1.5⇒70

Model	Engine	Year	Part No	Price
T1	1.2	⇒79	15500	£29.50
T1/T2	1.3-1.5	⇒70	15500	£29.50
T1/T2	1.3-1.6	71-79	15501	£37.50
Seal	1.2-1.6	70⇒	15510	£0.50
Oil Pressure Switch	⇒82	93440	£2.00	

## Engine Air Hose



50mm Heater Hose Paper/Aluminium



55/60mm Air Hose T2 1.7-2.0

Model	Engine	Year	Description	Part No	Price
T1/T2	1.2-1.6	⇒79	25mm Pre-heater Hose	20310	£1.85
T1/T2	1.2-1.6	63-79	50mm Fresh Air Hose	20320	£2.25
T1/T2	1.2-1.6	63-79	50mm As Above Aluminium	20321	£2.60
T1/T2	1.2-1.6	⇒79	32mm De-mist Hose	20323	£3.00
T2	1.7-2.0	73-79	55mm Air Blower Hose LH	20325	£4.50
T2	1.7-2.0	73-79	60mm Air Blower Hose RH	20326	£4.50
T1/T2	1.2-1.6	63-79	Hot Air Connecting Pipe	20305	£2.00
T1/T2	1.2-1.6	63-79	Air Hose Grommet	20307	£1.00

Beetle Heating System

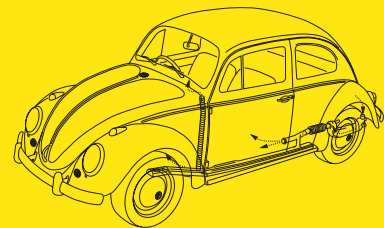

## Other Engine Parts



T2 Engine Foam Surround Oil Filler Cap 1.2-1.6 Fan Belt

Model	Engine	Year	Description	Part No	Price
T1/T2	1.2-1.6	→79	Thermostat - Genuine	17615	£32.50
T2	1.7-2.0	→82	Thermostat - Genuine	17616	£32.50
T1/T2	Most	→79	Tinware Screws	99199	£0.15
T1	Most	67-79	Eng-body Rubber Seal	87230	£7.45
T2	Most	72-79	Foam Engine Surround	87260	£12.50
T1	Most	72-79	Air Filter	12240A	£3.00
T2	Most	71-82	Air Filter	12241A	£3.85
T2	1.7-2.0	71-82	Oil Filter	12043	£3.75
T1/T2	Most	→79	Fuel Filter in line	12120	£0.60
T1/T2	1.2-1.6	→79	Fanbelt Dynamo 9.5 x 905	13300	£2.50
T1/T2	1.2-1.6	→79	Fanbelt Alternator 11.3 x 912	13303	£3.50
T2	1.7-2.0	71-79	Fanbelt 9.5 x 965	13343	£2.50
T25	1.6/2.0	80-82	Fanbelt 9.5x1165	13312	£3.50
T1/T2	1.2-1.6	→79	Tappet Screw	14488	£0.60
T1/T2	1.2-1.7	→79	Tappet Nut	14489	£0.15
T1/T2	1.2-1.6	60-79	Oil Filler Cap	15600	£1.50
T2	1.7-2.0	→79	Tappet	14534	£10.75

## Gearbox Mountings



T1 Front Gearbox Mount 66-72 Front Gearbox Mount 73-79 T1 Rear Gearbox Mount 52-72

Model	Engine	Year	Description	Part No	Price
T1	1.2-1.6	66-72	Front Mounting	31110	£6.50
T1	1.2-1.6	73-79	Front Mounting	31118	£8.50
T1	1.2-1.6	52-72	Rear Mounting	31115	£2.95
T1	1.2-1.6	73-79	Rear Mounting LH	31120	£6.00
T1	1.2-1.6	73-79	Rear Mounting RH	31122	£6.00
T1/T2		→72	Urethane mtg kit	99322	£16.75

## Engine Mountings



T2 1.6 68-71 T2 72-79 T2 1.7-2.0

Model	Engine	Year	Part No	Price
T2	1.6	68-71	10120	£8.50
T2	1.6	72-79	10121	£8.50
T2	1.7-20	71-79	10124	£8.50
T25	1.6/2.0 inner	80-90	10125	£6.50
T25	1.6/2.0 outer	80-90	10126	£6.50



## Gearbox Components



Gearshift Coupling Kit T1/T2 Gear Lever Boot T1/T2 Gearbox Seal

Model	Year	Description	Part No	Price
T1/T2/T25	60-90	Gearbox Seal	31150	£1.50
T1	→79	Shift Rod Bush	71701	£1.50
T2	→66	Shift Rod Bush	71701	£1.50
T2	→79	Gearshift Stop Plate	71706	£4.00
T1	64-79	Gearshift Coupling Kit	71710	£5.25
T2	68-79	Gearshift Coupling Kit	71710	£5.25
T1/T2	64-79	As above-but Urethane	71710A	£9.85
T1/T2	→79	Gearlever Boot	71711	£1.25
T1	→79	Gearbox Gasket Set	31105	£5.00

## Performance Air Filters

- Two sizes available-135mm/165mm
- Improves Engine breathing and performance
- Fits into Carb in place of existing system
- Washable Element
- 99176/78 £8.45 each



You can also place an order by emailing us at: [aircooled@gsgcarparts.com](mailto:aircooled@gsgcarparts.com)



### How to find your chassis no.

**Beetle Chassis no. location:**  
Stamped on the transmission tunnel under the back seat

**Van Chassis no. locations:**

1. On the vertical surface to the right of the engine
2. On the vehicle identification number (VIN) plate on the right hand side of the overhead fresh air duct in the cab
3. On the panel behind the drivers seat
4. The right hand engine cover plate
5. The left hand engine cover plate (late models)
6. On the identification number plate near the windscreen



### Beetle 1.2-1.6 Air-cooled Engine

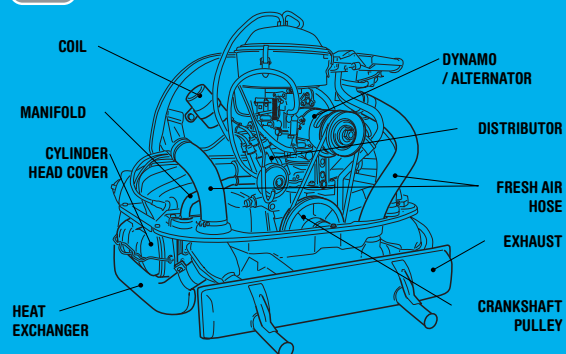

# fuel systems



## Carburettors



Single Port 30 Pict



Twin Port 34 Pict

Model	Engine	Year	Description	Part No	Price
T1/T2	1.2-1.6	→79	Single Port 30 Pict	18100	£68.00
T1/T2	1.3-1.6	→79	Twin port 34 Pict	18110	£92.50

## Carburettor Repair Kit

■ Kits include most Gaskets, Needle Valve, Accelerator and Choke Diaphragms

Model	Engine	Year	Part No	Price
T1/T2	1.2-1.6	→79	18140	£6.75
T1/T2	1.6 (31 Pict3/4)	→79	18140A	£6.75



1.2-1.6 Single Port Engines



1.3-1.6 Twin Port Engines



1.7-2.0 Engines

## Carburettor Parts



Electric Cut Off Valve 1.2-1.6



Choke Element 12v 1.2-1.6

Model	Engine	Year	Description	Part No	Price
T1	1.2-1.6	68-70	Cut-Off Valve G55	18220	£13.25
T2	1.2-1.6	67-70	Cut-Off Valve G55	18220	£13.25
T2	1.7-2.0	→79	Cut-Off Valve G55	18220	£13.25
T1/T2	1.2-1.6	71-79	Electro Cut-Off Valve	18222	£13.25
T1	1.2-1.6	68-79	Choke Element 12v	18231	£12.50
T1/T2	1.2-1.6	→79	Return Spring-Acc	18144	£0.85
T1/T2	1.2-1.6	→79	Needle Valve	18144A	£1.50

## Fuel Pumps



1.2-1.6 →71



1.2-1.6 72-73



1.2-1.6 74-7.

Model	Engine	Year	Part No	Price
T1/T2	1.2-1.6	→73	18351	£12.50
T1/T2	1.2-1.6	74-79	18352	£12.50
T25	1.6	80-82	18355	£35.00
T25	2.0	80-82	18358	£58.50

## Fuel Pump Parts

■ It is advisable to fit a new Fuel Pump Push Rod when fitting a new Pump

Model	Engine	Year	Description	Part No	Price
Most	-	-	Fuel hose 5mm	18602	£1.70
Most	-	-	Fuel Filter	12120	£0.60
T1/T2	1.2-1.6	→79	Fuel Pump Pedestal	18520	£2.50
T1/T2	1.2-1.6	60-73	F/Pump Push Rod	18530	£3.50
T1/T2	1.3-1.6	74-79	F/Pump Push Rod	18531	£3.50
Most	-	→79	Hose Clip	18610	£0.50
Most	-	-	Vacuum Hose 3mm	18600	£1.70



## Fuel Tanks

■ Make sure Securing Bolts are correctly fitted  
 ■ Advisable to fit new Petrol Hose and Clips

Model	Year	Part No	Price
T1	→67	29309	£36.00
T1	68-79	29310	£36.00
1302/3	71 →	29311	£47.50
T25	80-90 (48mm neck)	29312	£65.00



Petrol Tank T1 →67



Petrol Tank 1302/3 71 →



Petrol Tank T1 68-79

## Petrol Caps



T1 68-72



T1 68-72 - Locking

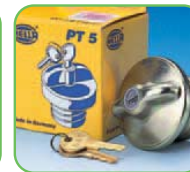

T1 72-79 - Locking

Model	Year	Description	Part No	Price
T1	68-72	Non Locking	29400	£3.00
T1	72-79	Non Locking-Screw On	29401	£3.00
T1	68-72	Locking	29402	£6.50
T2	72-73	Locking	29402	£6.50
T1	72-79	Locking-Screw On	29403	£6.50
T2	74-79	Locking	29415	£6.50
T25	80-90	Locking	29420	£6.50





# clutch Kits

## Clutch Kits

- Complete 3 Piece Kits
- Made in Germany
- Original Equipment



Model	Engine	Year	Size	Part No	Price
T1	1.2	⇒72	180mm	18900L	£52.00
T1	1.3	⇒70	180mm	18900L	£52.00
T1	1.2	73-79	180mm	18901	£43.50
T1	1.3	71-79	180mm	18901	£43.50
T1/T2	1.5-1.6	⇒70	200mm	18902	£69.50
T1	1.6	71-79	200mm	18903	£54.00
T2	1.6	71-75	200mm	18903	£54.00
T2/T25	1.6	76⇒	215mm	18904	£69.50
T2	1.7	71-73	210mm	18905	£76.00
T2/T25	2.0	⇒82	228mm	18922	£65.00

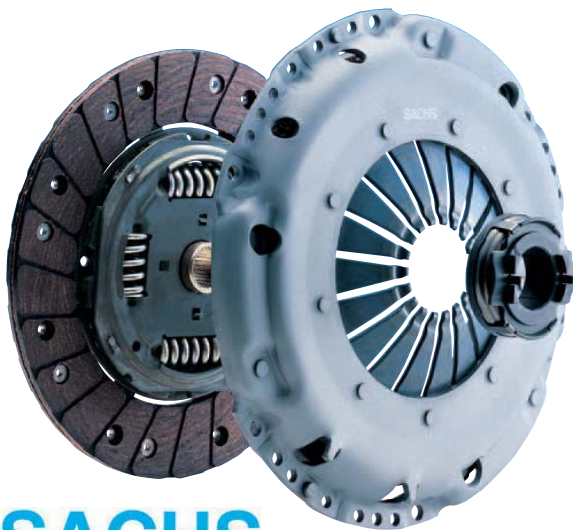

# SACHS

## Clutch Friction Plates



See pg 46 for details on how to order

Model	Engine	Size	Part No	Price
T1	1.2/1.3	180mm	19201	£17.50
T1	1.5-1.6	200mm	19203	£21.00
T2	1.5-1.6 ⇒75	200mm	19203	£21.00
T2/T25	1.6 76⇒	215mm	19204	£31.00



### Technical Tips

When fitting a clutch use an old broom handle for centering. Also turn the crankshaft pulley a fraction of a turn this will engage the engine to the gearbox. Upon fitting a new clutch remember to remove packing clips, also make sure the clips on the release bearing are tight.

## Clutch Release Bearings



Early Style Release Bearing

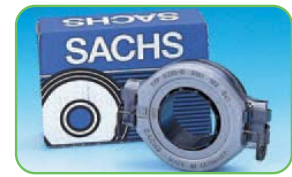

Later Style Release Bearing

Model	Engine	Year	Part No	Price	
T1	1.2	⇒72	19300	£14.75	
T1	1.3-1.5	⇒70	19300	£14.75	
T2	1.5-1.6	⇒70	19300	£14.75	
Release Bearing Clips For Above				19300A	£0.25
T1	1.2	73-79	19301	£11.50	
T1/T2	1.3-1.6	71-79	19301	£11.50	

## Other Clutch Parts



Clutch Operating Shaft



Clutch Shaft Repair Kit



Release Bearing Guide

Model	Year	Description	Part No	Price		
T1 1.2	⇒72	Clutch operating shaft	19500	£6.25		
T1 1.3-1.5	⇒70	Clutch operating shaft	19500	£6.25		
T2	⇒67	Clutch operating shaft	19500	£6.25		
T1	72-79	Clutch operating shaft	19504	£13.00		
T1	66-72	Clutch shaft repair kit	19520	£3.50		
T2	66-75	Clutch shaft repair kit	19520	£3.50		
Use as fitted				Release bearing guide	19530	£4.50
T1	⇒72	Clutch return spring	19540	£1.00		
T2	⇒75	Clutch return spring	19540	£1.00		
T1	72-74	Clutch return spring	19541	£1.00		
T1	74⇒	Clutch return spring	19542	£2.00		
T1/T2	⇒79	External clutch op shaft	19546	£5.00		

## Clutch Cable / Conduits

- Original Equipment Quality
- Made in Germany
- Extensive Range

Model	Year	Part No	Price
T1	63-71	71500	£3.50
T1	72-74*	71502	£3.50
T1	74-79	71504	£3.50
T2	55-59	71508	£4.25
T2	62-67	71508	£4.25
T2	68-69	71512	£4.25
T2	70-71	71515	£4.25
T2	72-79	71518	£4.25
T25 1.6	80-90	71525	£8.50
T1 Conduit	⇒71	71670	£2.80
T2 Conduit	⇒67	71670	£2.80
T1 Conduit	72-73	71671	£2.80
T2 Conduit	68-79	71671	£2.80
T1 Conduit	74-79	71672	£2.80

\* Up to chassis no. 114 2663 259



clutch kits

# exhausts

## Exhausts - Beetle

- Quality Product
- Made in Germany

Model	Year	Description	Part No	Price
T1 1.2	63-79	Exhaust	20002	£32.00
T1 1.2	63-79	Heat Exchanger LH/RH	20100/2	£45.00
T1 1.3-1.6	65-71	Exhaust	20003	£32.00
T1 1.3-1.6	65-71	Heat Exchanger LH/RH	20100/2	£45.00
T1 1.3-1.6	72➔	Exhaust	20004	£32.00
T1 1.3-1.6	72➔	Heat Exchanger LH/RH	20100/2	£45.00
T1 1.3	74➔	Exhaust	20005	£37.00
T1 1.6	76➔	Exhaust	20005	£37.00
T1 1.3/1.6	63➔	Heat Exchanger LH/RH	20100/2	£42.50



## Tailpipes



Model	Engine	Size	Year	Part No	Price
T1	1.2	20 x 275mm	➔73	20064	£1.95
T1	1.3-1.5	20 x 275mm	➔67	20064	£1.95
T1	1.2	20 x 250mm	74➔	20066	£1.95
T1	1.3/1.5/1.6	20 x 250mm	68-79	20066	£1.95

## Taper Tips

- Fit All Beetles
- 20062 £10.00 per pair



## Fitting Kits



Fitting Kits	Models	Part No	Price
Tailpipe Fitting Kit	All Beetles	20226	£1.25
Exhaust Fitting Kit	All Beetles	20200	£4.85
Zoom Tube	Fits All Models	20061	£19.75
J Tubes	Replace Heat Exchangers	99200	£11.00



Beetle  
1200  
63-79

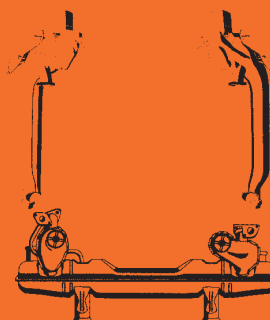

Beetle  
1.3/1.5/1.6  
65-71  
Single Hot Spot

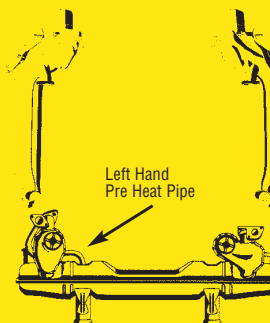

Beetle  
1.3-1.6  
72➔  
Single Hot Spot

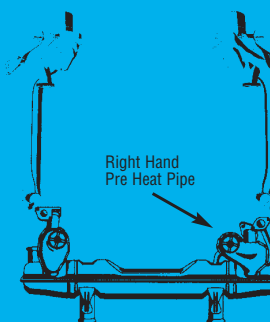

Beetle  
1.3 74➔  
1.6 76➔  
Twin Hot Spot

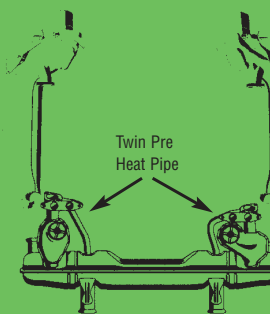

## Heat Exchanger Parts

Model	Year	Description	Part No	Price
T1	63-79	Lever Kit LH/RH	20260/1	£4.25
T1/1302	65-72	Heater Cable	74104	£3.00
T1	65-72	Heater Cable-Rear Well	74105	£3.00
T1	73-79	Heater Cable	74107	£3.00
T1	73-79	Heater Cable Rear Well	74108	£3.00
1303	72-79	Heater Cable	74109	£3.00
T1/T2	➔79	H/Exchanger to Exhaust Clamp	20245	£1.00
T1/T2 ➔1.6	➔79	Repair Pipe-Heat Exchanger-sml	20265	£2.20
T1/T2 ➔1.6	➔79	Hot Air Connecting Pipe	20305	£2.00
T1 1.3	74➔	Twin Hot Spot Gasket	20190	£1.00
T1 1.6	76➔	Twin Hot Spot Gasket	20190	£1.00

## Van Exhausts



Van Exhaust Fitting Kit



Tailpipe Fitting Kit

Model	Year	Description	Part No	Price
T2 1.5/1.6	63-76	Exhaust	20013	£32.50
T2 1.5/1.6	63-76	Muffler Pipe	20050	£7.50
T2 1.5/1.6	63-76	Tailpipe	20069	£3.00
T2 1.5/1.6	63-76	Tailpipe Bracket	20052	£3.00
T2 1.5/1.6	63-79	Exhaust Fitting Kit	20205	£8.00
T2 1.5/1.6	63-76	Tailpipe Fitting Kit	20228	£4.75
T2 1.5/1.6	63-79	Heat Exchanger LH/RH	20100/2	£45.00
T2 1.6	77-79	Exhaust	20014	£32.50
T2 1.6	77-79	Muffler Pipe	20053	£8.50
T2 1.6	77-79	Exhaust Fitting Kit	20205	£8.00
T2 1.6	77-79	Tailpipe Fitting Kit	20229	£3.50
T2 1.6	77-79	Heat Exchanger LH/RH	20100/2	£45.00
T25 1.6	6/80-9/82	Exhaust	20017	£67.00
T25 1.6	5/79-6/80	Manifold U RH	20040	£18.75
T25 1.6	5/79-6/80	Manifold LH	20041	£49.95
T25 1.6	6/80-9/82	Manifold U RH	20042	£27.00
T25 1.6	5/79-9/82	Manifold RH	20044	£12.00
T25 1.6	6/80-9/82	Exhaust Tailpipe Fitting Kit	20208	£8.00
T25 1.6	6/80-9/82	Manifold Fitting Kit	20209	£8.00

PLEASE CHECK YOUR ENGINE CODE, EXHAUST SYSTEM CHANGES ON ENGINE CODE CT 073818

T2/T25 1.7-2.0	72-82	Exhaust	20022	£64.50
T2/T25 1.7-2.0	72-82	Exhaust - Italian	20022A	£43.50
T2/T25 1.7-2.0	72-79	Tailpipe	20076	£6.50
T25 2.0	80-82	Tailpipe	20078	£6.75
T2/T25 1.7-2.0	72-82	Exhaust Fitting Kkit	20215	£6.50
T2/T25 1.7-2.0	72-82	Tailpipe Gasket	20242	£2.00
T2 1.7-2.0	72-78	Heat Exchanger LH/RH	20110/1	£96.00
T2 1.7-2.0	79 only	Heat Exchanger LH/RH	20114/5	£120.00
T25 2.0	80-82	Heat Exchanger LH/RH	20118/9	£86.00
T2 1.7-2.0	72-79	Heater Control Box LH/RH	20135/6	£31.00
T25 2.0	80-82	Heater Control Box LH/RH	20145/6	£31.00
T2 1.7-2.0	72-78	Copper Ring	20194	£1.00
T2/T25	79-82	Heat Exchanger Gasket	20196	£2.15
T2	73-79	Heater Cable LH/RH	74129/30	£7.95



Van H/Exchanger 1.7-2.0 →78



Van Exhaust 1.7-2.0 72-82

## Heat Exchanger Parts



Van Exhaust Fitting Kit



Tailpipe Fitting Kit

Model	Year	Description	Part No	Price
T2	63-67	Lever Kit LH/RH	20260/1	£4.25
T2	68-71	Heater Cable LH/RH	74120	£7.95
T2	72 only	Heater Cable LH/RH	74122/4	£7.95
T2	73-79	Heater Cable LH/RH	74126/8	£7.95
T2	-	Heater Cable Fixing Kit	20250	£1.50



Van  
1.5-1.6  
63-76

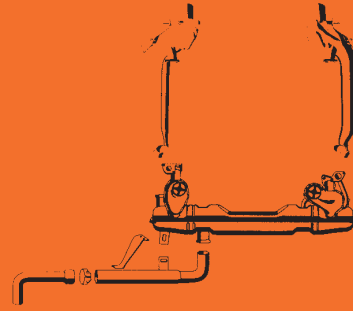

Van  
1.6  
77-79

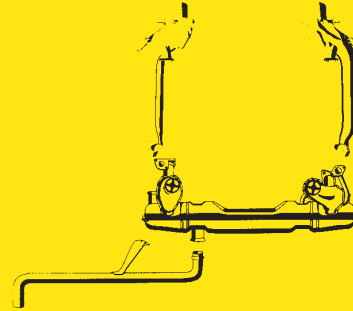

Van  
1.6  
5/79-9/82

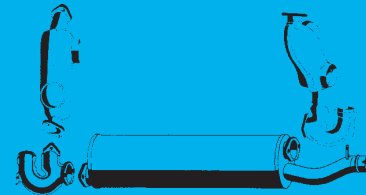

Van  
1.7-2.0  
72-82

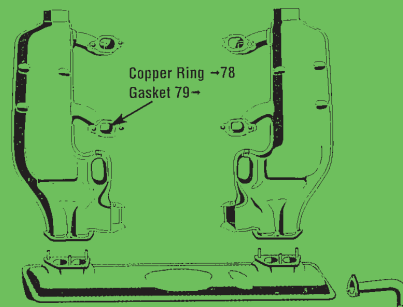

exhausts

Remember GSF offer you the complete mail order service

- Express 24 hour delivery on the UK mainland (subject to postcode)
- Special delivery rates to the Scottish Islands, N.Ireland and Eire
- We export worldwide – goods fully insured – fast efficient service

## sports exhausts

Please note all Sports Exhaust Systems do not fit 1200 Engines or vehicles fitted with Twin Hot Spots Manifolds, if in doubt, please ring us.

### Kadron K300 20007

- The Kadron Kit comes complete with Manifold and Tailpipe and two pieces of Fresh Air Hose
  - Please note that this Exhaust is Rather loud!
  - T1/T2 1.3/1.5/1.6 Single Hot Spot Models
  - Can also be fitted to Vans 1.5/1.6
- £46.25



### Turbo Trip Exhaust 20008C

- Fits Beetle 12-1600 Models
  - Gives a Sports Sound
  - Exhaust hides under the Rear Apron
  - 5-10% Power Increase
- £39.50



### Monza 4-Tip Exhaust 20009

- Monza 4-Tip Exhaust fits T1/T2 1.3/1.5/1.6 Single Hot Spot Models
  - Gives a Sports Sound
  - Sporting appearance High Quality Chrome Tips
  - 5-10% Power Increase
  - Freeflow system-reduces back pressure
- £42.50



### Dual Silencer 20008D

- Fits Beetle 13-1600 Models
  - Increases Engine Breathing
  - More Power/Economy
  - Chrome Tailpipe Tips
- £61.50



Sports exhausts

Visit our website [www.gsfcarparts.com](http://www.gsfcarparts.com)

- Secure Online Shop
- Lively Discussion Forums
- Branch Maps
- Downloads
- Monthly Special Offers



# suspension



## Front Axle Beams



Front Axle Beam  
66→LHD  
(needs converting)\*



Front Axle Beam Assembly  
65→LHD  
(needs converting)\*  
For Vehicles with Discs



Front Axle Beam Assembly  
65→LHD  
(needs converting)\*  
Adjustable Beam

Model	Year	Description	Part No	Price
T1	66-79	Front Axle Beam	42200	£85.00
T1	66-79	Front Axle Beam For Vehicles with Discs	42199	£185.00
T1	66-79	Front Axle Beam With built in Adjusters	42201	£85.00

\* To convert Front Axle Beams from left hand drive to right hand drive the bracket for the Steering Damper needs welding to the opposite side of the beam.

## Sway Aways



See pg 46 for  
details on how  
to order

Model	Year	Part No	Price
King Pin Models	→65	99406	£11.15
Ball Joint Models	66→	99405	£11.15

Weld on Front Beam Adjusters, cut and weld into Front Axle Beam to lower

## Ball Joints



Beetle Ball Joint



1302/3 →73



Van Ball Joints

Model	Year	Description	Part No.	Brazil	Germany
T1	66→	Upper	42400/1	£4.25	£7.50
T1	66→	Lower	42402/3	£4.25	£7.50
1302/3	→73		42404A	£14.50	-
1303	73-79		42406	£9.50	-
T2	68-79	Upper/Lower	42410	-	£10.00
T25	80-90	Upper	42415A	£9.50	-
T25	80-90	Lower	42417	£9.50	-



## King Pin and Link Pin Sets



King Pin Kit Beetle →65



Link Pin Kit Beetle →65

Model	Year	Description	Part No	Price
T1	47-65	King Pin Kit	42390	£12.00
T1	47-65	Link Pin Kit	42391	£23.50

## Bump Stops - Van 68-79



T2 Upper Bump Stop



T2 Lower Bump Stop

Model	Year	Description	Part No	Price
T2	68-79	Upper Bumper Stop	42500	£6.00
T2	68-79	Lower Bumper Stop	42501	£6.00
T2	68-79	Lock Plate	42505	£0.80

## Anti-Roll Bars



Anti-Roll Bar



Van Anti-Roll Bar Fitting Kit



Beetle Anti-Roll Bar Fitting Kit

Model	Year	Description	Part No	Price
T1	68-79	Anti-Roll Bar	43280	£9.00
T2	68-79	Anti-Roll Bar	43285	£14.00
T1	66-79	Anti-Roll Bar Fitting Kit	43290	£4.50
T1	66-79	Anti-Roll Bar Fitting Kit	43291*	£9.75
T2	68-79	Anti-Roll Bar Fitting Kit	43295	£5.25

\*Genuine

## Steering Knuckles



Beetle fitted with Discs (exc 1302/3)

Model	Year	Description	Part No	Price
T1	66-79	LH - Original	42205	£32.00
T1	66-79	RH - Original	42206	£32.00

You can also place an  
order by emailing us at:  
[aircooled@gsfcarparts.com](mailto:aircooled@gsfcarparts.com)

Visit our website [www.gsfcarparts.com](http://www.gsfcarparts.com) for  
secure online ordering and fast delivery

# shock absorbers



## Shock Absorbers - Front

- Original Quality
- Made in Germany
- We advise fitting Shocks in Pairs

**SACHS BOGE**

Model	Year	Part No	AQ	Sachs
T1	53-65	45504/5	£9.45	£14.00
T1	66-79	45506/7	£9.45	£14.00
T1 Gas	66-79	45507A	£13.50	-
1302/3	→73	45508/9	£16.00	£24.50
1302/3	74-75	45510/11	£16.00	£24.50
1302/3	75→	45512	-	£24.50
T2	70-79	45520/1	£9.45	£16.25
T25	80-90	45525/6	£13.50	£22.50

## Shock Absorbers - Rear



Model	Year	Part No	AQ	Sachs
T1	→79	45600/1	£9.50	£15.00
T1 Gas	66-79	45601A	£13.50	-
1302/3	→79	45602/3	£9.50	£15.00
T2	68-71	45606	£11.00	-
T2	72-79	45608/9	£11.00	£19.25
T25	80-90	45613	£16.00	-

It is advisable to fit a Top Fitting Kit to Front Beetle Shocks

## Other Suspension Parts



Front Shock Sleeve - Beetle Shock Abs Fitting Kit - Beetle

Model	Year	Description	Part No	Price
T1	66-79	Shock Abs Fitting Kit	45690	£4.25
T1	66-79	Front Shock Sleeve	45691	£2.00
T1/1302/3	70-79	Spring Plate Bush Outer	45801	£3.25
T1/1302/3	70-79	Spring Plate Bush Inner	45803	£3.25
T1/1302/3	70-79	Spring Plate Bush Inner	45804	£3.25
1302/3	70-79	Front Spring	45410	£16.50
T25	80-90	Front Spring	45412	£29.80
T25	80-90	Rear Spring	45495	£36.50

## CV Joints

- Original Quality
- Made in Germany
- World Leading Supplier of CV Joints

Model	Year	Part No	Price
T1	68-79	43825	£28.50
T2/T25	68-90	43826	£28.50



See pg 46 for details on how to order

## CV Boot Kits/Other Parts



Van Constant Velocity Boot Kit



Split Axle Gaiter - Beetle

Model	Year	Description	Part No	Price
T1	→79	Split Axle Gaiter	45005	£3.00
T1	68→	CV Joint Boot	45006	£2.75
T2	68-79	CV Joint Boot	45007	£2.75
T2/T25	68-90	CV Joint Boot Kit	45008	£6.25
T1/T2/T25	68-90	CV Joint Bolt	45100	£0.40

## Wheel Bearings - Front



Model	Year	Inner/Outer	Part No	Price
T1	→65	Inner/Outer	41200/1	£8.50
T1	66-68	Inner	41202	£3.00
T1	68-79	Inner	41203	£3.00
T1	64-79	Outer	41204	£3.00
T2	64-79	Inner	41205	£4.00
T2/T25	64-90	Outer	41206	£4.00
T25	80-90	Inner	41210	£6.95

## Wheel Bearings - Rear

Model	Year	Inner/Outer	Part No	Price
T1 (no CV Joints)	53→	Inner	41300	£11.50
T1 (with CV Joints)	68-79	Inner	41301	£5.75
T1 (with CV Joints)	68-79	Outer	41302	£13.50
T2/T25	68-90	Inner	41305	£5.50
T2	64-70	Outer	41308	£19.75
T2/T25	71-90	Outer	41310	£11.00

## Oil Seals



Rear Hub Seal Oil Kit - T1/T2



Bearing T1/T2

Model	Year	Description	Part No	Price
T1 /T2	→79	Rear Hub Oil Seal Kit	41331	£2.50
T1	→79	Rear Hub Oil Seal	41330	£1.50
T2	→67	Rear Hub Oil Seal	41330	£1.50
T2/T25	68-90	Rear Hub Oil Seal	41335	£2.50
T1	→65	Front Hub Oil Seal	41250	£2.00
T1	68-79	Front Hub Oil Seal (Drum)	41253	£1.50
T1	68-79	Front Hub Oil Seal (Disc)	41254	£1.50
T2	68-79	Front Hub Oil Seal	41260	£2.00
T25	80-90	Front Hub Oil Seal	41263	£2.00
T1	→79	Front Hub Grease Cap	41257	£2.00

# steering parts

## Steering Boxes



T1 Steering Box



Steering Coupling T1/T2



1302/3 Steering Box

Model	Year	Description	Part No	Price
T1	→79	Steering Box	43000	£62.00
T1	→79	Steering Coupling	43050	£4.50
T2	68-79	Steering Coupling	43053	£8.50
T25	80-90	Steering Coupling	43054	£8.50
T25	80-90	Steering Rack	43009	ex £62.00
T25	80-90	S/Rack Mtg Bush	43028	£3.50
T25	80-90	Steering Rack Boot	43070	£3.50

## Universal Joint & Shaft



LH 1302/3 →74 RH 1302/3 75-79

Model	Year	Part No	Price
1302/3	→74	43060	£27.50
1302/3	75-79	43061	£27.50

You can also place an order by emailing us at: [aircooled@gsfcarparts.com](mailto:aircooled@gsfcarparts.com)

## Tie Rods Complete



T2 Tie Rods 68-79



Model	Year	Description	Part No	Price
1302/3	→74	Tie Rod - Centre	43511	£32.50
1302/3	→74	Tie Rod - LH/RH	43515	£32.50
T2	68-79	Tie Rod - Adj	43550	£21.00
T2	68-79	Tie Rod - Fixed	43555	£16.50
T25	80-90	Tie Rod	43561	£17.50

## Tie Rod Ends



Tie Rod End



Tie Rod End with Steering Damper Eye

Model	Year	Description	Part No	Price
T1	55-68	Outer LH	43650	£4.95
T1	55-68	Outer RH	43655	£4.95
T1	55-68	Inner RH	43656	£4.95
T1	66-68	Inner LH	43660	£8.45
T1	68-79	Inner RH	43662	£4.95
T1/T2	68-79	Outer LH	43666	£4.95
T1	68-79	Inner LH & S/Damper	43672	£8.45
T1/T2	68-79	Outer RH	43671	£4.95

## Steering Dampers



Model	Year	Part No	Brazilian	German
T1	62-79	43100/1	£9.30	£14.00
1302/3	70-79	43102/3	£9.30	£14.50
T2	→79	43104/5	£9.30	£14.00
T1/T2	Bush	43125	-	£1.50

\* It is advisable to fit a new Steering Damper Bush when fitting a new Steering Damper.

## Drag Links

■ Connects the Drop Arm on the Steering Box to the Centre Pivot Pin on the Front Axle

Model	Year	Part No	Price
T2	55-67	43540	£32.50
T2	68-79	43541	£27.50



See pg 46 for details on how to order

## Swivel Pin Kits



T2 68-79



T2 →67

Model	Year	Part No	Price
T2	→67	43250	£19.00
T2	68-79	43251	£16.00

## Steering Parts

Model	Year	Description	Part No	Price
T25	80-90	Wishbone Bush (Upper)	42258	£11.00
T25	80-90	Link Arm Stabiliser Rubber	42273	£1.30
T25	80-90	Link Arm (from Stab/Bar)	42273A	£35.00
T25	80-90	Anti-roll Bar Bush	43300	£2.20

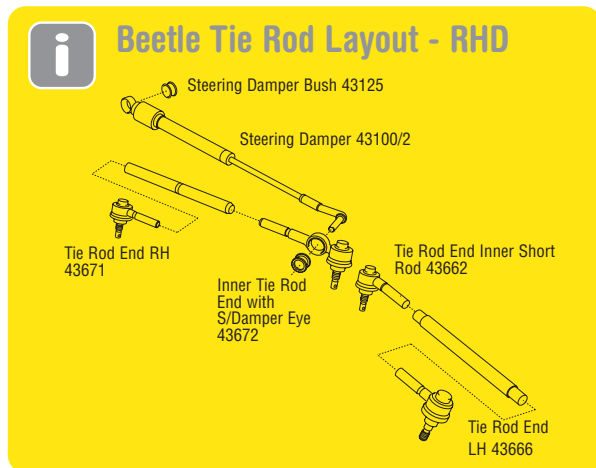

steering parts

# brakes



## Front Brake Drums



T1 →67 5 Stud

T1 →68

Model	Year	Description	Part No	Price
T1	58-65	5 Stud	62205	£27.50
T1	66-67	5 Stud	62208	£27.50
T1	68-79	4 Stud	62211	£15.00
1302/3	70-79	4 Stud	62212C	£27.50

## Rear Brake Drums



T1 68→

T1 →67 5 Stud

T2 71-79

Model	Year	Description	Part No	Price
T1 1.3	57-66	5 Stud	62220	£21.75
T1 1.2	57-67	5 Stud	62220	£21.75
T1	68-79	4 Stud	62223	£21.75
T2	68-70	-	62225	£42.00
T2	71-79	-	62228	£24.50
T25	80-90	-	62230	£24.50

## Brake Discs



Beetle Discs 67→

Van Disc 73-79

Model	Year	Part No	Price
T1 1302/3	67-79	62305	£21.50
T2	71-72	62310	£30.00
T2	73-79	62315	£22.50
T25	80→	62320	£25.00

## Front Brake Shoes

- Original Equipment Quality
- Made in Germany
- Asbestos Free

Model	Year	Part No	Price
T1	65-79	63106	£9.00
1302/3	70-79	63108	£13.50
T2	65-70	63112	£19.75



**PAGID**

## Rear Brake Shoes

Model	Year	Part No	Price
T1	65-68	63115	£9.75
T1 1302/3	68-79	63106	£9.00
T2	64-70	63118	£19.75
T2	71	63120	£19.75
T2	72-73	63122	£19.75
T2	*73-79	63124	£14.50
T25	80-90	63126	£19.75

\*PLEASE NOTE: FROM CHASSIS NO. 213 2102 497

## Wheel Bolts/Hub Nuts

Model	Year	Description	Part No	Price
T1	→67	Wheel Bolt	45110	£1.00
T1	68-79	Wheel Bolt	45115	£1.00
T2	→79	Wheel Bolt	45115	£1.00
T2/T25	71-90	Wheel Nut	45116	£1.00
T2/T25	71-90	Wheel Stud Rear	45118	£2.60
T1	67-79	Hubnut Rear	45125	£3.00
T2/T25	64-90	Hubnut Rear	45130	£3.00
T1/T2	-	Split Pin Rear	45150	£0.30

## Brake Pads

- Original Supplier to VW-Audi
- Made in Germany
- Asbestos Free

Model	Year	Part No	Price
T1	66-71	64206A	£10.00
T1 (2 Pin)	72	64211A	£10.00
T1 (Kidney)	→73	64214A	£13.50
T2	71-72	64218A	£11.50
T2/T25	73-85	64222A	£11.50



**PAGID**

## Opportunities at

**GSFCAR PARTS**

“We always have vacancies for the right people”

If you feel you would like to be one of us please get in touch by visiting our website at [www.gsfcarparts.com](http://www.gsfcarparts.com), email: [careers@gsfcarparts.com](mailto:careers@gsfcarparts.com) or contact Dave Atkinson, GSF Car Parts Ltd, The Planet Centre, Armadale Road, Feltham, Middlesex TW14 0LW



## Brake Shoe Backing Plates



T1 67-79 with Discs

T1 Rear 68-79

T2 Rear 71-79

Model	Year	Front/Rear	Part No	Price
T1 (Discs)	67-79	Front	62459A	£12.00
T1	68-79	Rear LH	62459B	£17.50
T1	68-79	Rear RH	62459C	£17.50
T2	71-79	Rear LH/RH	62460/5	£32.00
T1/T2	71	Back Plate - Plug	62480	£0.40

## Brake Shoe/Disc Fitting Kits



T1 Front/Rear Fitting Kit 65-79



with Pull off Springs

Model	Year	Description	Part No	Price
T1	65-79	Front Shoe	62530*	£3.50
T1	68-79	Rear Shoe	62530*	£3.50
T1 1.2/1.3	70-79	Front/Rear Shoe	62531*	£4.50
1302/3	70-79	Rear shoe	62531*	£4.50
*The above 2 kits include pull off springs				
1302/3	70-79	Front Shoe	62532	£3.00
T2	70	Rear Shoe	62532	£3.00
T2	71-79	Rear Shoe	62534	£3.50
T2	70	Front Shoe	62534	£3.50
T2	73-79	Front Disc	62558	£4.00

## Miscellaneous Brake Parts



Brake Star Adjuster



Adjuster Bolts

Model	Year	Description	Part No	Price
T1	65-79	Adjuster Bolt	62490	£1.00
T2	55-79	Adjuster Bolt	62495	£1.50
T1/T2	-	Brake Star Adjuster	62500	£1.00
T1/T2	-	Horse Shoe Clip Pin	62505	£0.90
T1/T2	-	Horse Shoe Clip	62510	£0.15
T1	-	Grease Cap - Front	41257	£2.00

## Brake Calipers



Beetle Caliper



Van Caliper

Model	Year	Part No	Price
T1 with pads	67-79	65606	each £29.50
T1 (ATE)	67-79	65605	pair £65.00
T2/T25	73-86 - Exchange	65621/2	each £58.50

## Brake Caliper Repair Kits

Model	Year	Part No	Price
T1 (Single Pin)	72	65688	£8.50
T1 (2 Pin)	72-73	65690	£8.50
T2	72	65694	£11.50
T2/T25	73-86	65696	£10.00

## Brake Master Cylinders



Beetle Single Circuit Cylinder



Beetle 1302/3 Dual Circuit Cylinder

Model	Year	Part No	Price
T1	47-64	65205	£14.25
T1	65-68	65206	£14.25
T1	68-79	65210	£58.00
T1 (LHD)	68-79	65212	£25.00
1302/3	70-79	65215	£58.00
1302/3 (LHD)	70-79	65216	£25.00
T2	52-67	65220	£19.25
T2 (no Servo)	70 only	65223	£45.00
T2 (22.2mm)	68-69	65224	£68.00
T2 (no Servo)	71-79	65230	£30.00
T2 (with Servo)	71-79	65232	£32.00
T25 (with Servo)	80-90	65237	£56.00



T2 Single Circuit Cylinder



Van Cylinder 71

## Brake Master Cylinder Repair Kits



T1 Repair Kit 68-71



T2 Repair Kit 71-79 No Servo

Model	Year	Part No	Price
T1	68-71	65307	£16.00
T1/1302/3	72-79	65310	£16.00
T2 (no Servo)	71-79	65325	£18.50



### Technical Tips

After replacing a brake wheel cylinder – it is advisable to renew the brake fluid in the system.

It is advisable to check on the condition of the rubber boots on all wheel/brake master cylinders and caliper seals. If there is any sign of deterioration or leaks you must replace or failure will result.

## Front Wheel Cylinders



T2 Front ➔70



T2 Rear 72➔

Model	Year	Part No	Brazil	German
T1	58-79	65401/3	£4.50	£11.50
1302/3	73-79	65405	£7.25	-
T2 (LH)	64-70	65410	£9.50	-
T2 (RH)	64-70	65415	£9.50	-

## Rear Wheel Cylinders

Model	Year	Part No	Brazil	German
T1	52-57	65419	-	£35.00
T1	58-64	65420	£5.95	-
T1	65-67	65423	£5.95	-
T1	68➔	65424/6	£4.50	£11.50
T2	55-71	65430/1	£9.60	£12.50
T2/T25	72-90	65434/6	£6.25	£10.00

## Bleed Nipples

Model	Year	Description	Part No	Price
T1/T2	➔79	For Wheel Cylinder Rear	65950	£0.80
T1/T2 (ATE)	➔79	For Caliper	65962	£1.50
T1 (Girling)	➔79	For Caliper	65967	£2.50

## Flexible Brake Hoses - Front



You can also place an order by emailing us at: [aircooled@gsfcarparts.com](mailto:aircooled@gsfcarparts.com)

Model	Year	Length	Part No	Price
T1/T2	➔64	470mm	65750	£5.00
T1	65-66	440mm	65753	£5.00
T1 (Drum)	67-79	390mm	65756	£5.00
T1 (Discs)	67-79	360mm	65759	£5.00
1302/3	70-79	320mm	65765	£5.00
T2	56-67	440mm	65753	£5.00
T2	68-70	350mm	65769	£5.00
T2	71-79	320mm	65765	£5.00
T25	80-86	405mm	65775	£5.00

## Flexible Brake Hoses - Rear

Model	Year	Length	Part No	Price
T1 Swing Arm	➔79	270mm	65850	£5.00
T1 CV Joints	68-79	240mm	65855	£5.00
T2	➔67	270mm	65850	£5.00
T2 (RH)	68-79	270mm	65850	£5.00
T2 (LH)	68-79	280mm	65860	£5.00
T25	80-90	205mm	65875	£5.00
All Models	-	Brake Pipe Clip	65897	£0.60

## Miscellaneous Brake Parts

Model	Year	Description	Part No	Price
T1/T2	-	T Piece Connector	65895	£7.50
T1	66-79	Brake Fluid Reservoir Cap	65930	£0.50
T2	68-79	Brake Fluid Reservoir Cap	65930	£0.50

## Steel Brake Pipe Kits



See pg 46 for details on how to order

Model	Year	Description	Part No	Price
T1	60-67	Single Circuit	65970	£13.00
T1	68-79	Dual Circuit	65972	£13.00
1302/3	70-79	Disc Brakes	65973	£13.00
T2	71-79	Disc Brakes	65976	£16.50

## Brake Disc Conversion Kit 99300

- For Beetles fitted with Drum Brakes from 8/65➔ (not 1302/3)
- Kit consists of:
  - 2 x Brake Discs
  - 2 x Outer Wheel Bearings
  - 2 x Inner Wheel Bearings
  - 2 x Oil Seals
  - 2 x Caliper with Pads
  - 2 x Steering Knuckles
  - 2 x Brake Backing Plates
  - 2 x Brake Hoses
  - 2 x Bolts
- £195.00



Remember GSF offer you the complete mail order service

Express 24 hour delivery on the UK mainland (subject to postcode)

Special delivery rates to the Scottish Islands, N.Ireland and Eire

We export worldwide – goods fully insured – fast efficient service

# cables

- Original Equipment
- Made in Germany
- Excellent Fit

# GEMO

## Handbrake Cables

Model	Year	Part No	Gemo
T1	58-64	73100	£6.00
T1	65-67	73101	£6.00
T1	68-72	73102	£6.00
1302	70-72	73103	£6.00
1303	72-79	73104	£6.00
T1	73-79	73104	£6.00
T2	64-67	73106	£7.50
T2	67-68	73107	£7.50
T2	68-71	73108	£7.50
T2	72-79	73109	£7.50
T25 (Rear)	80-90	73110	£7.50
T25 (Front)	80-90	73111	£7.50

## Clutch Cables

Model	Year	Part No	Gemo
T1	63-71	71500	£3.50
T1	72-74	71502	£3.50
Up To Chassis No 114 2663 259			
T1	74-79	71504	£3.50
From Chassis No114 2663 260			
T2	55-59	71508	£4.25
T2	62-67	71508	£4.25
T2	68-69	71512	£4.25
T2	70-71	71515	£4.25
T2	72-79	71518	£4.25
T25	80-90	71525	£8.50
T1/T2	Wing nut	71660	£1.00
T2 Clutch Cable Pin	70-79	71664	£1.30

## Clutch Cable Conduit

Model	Year	Part No	Gemo
T1	⇒71	71670	£2.80
T1	72-73	71671	£2.80
T1	74-79	71672	£2.80
T2	⇒67	71670	£2.80
T2	68-79	71671	£2.80

## Accelerator Cables

Model	Year	Part No	Gemo
T1	60-66	71205	£2.40
T1	67-71	71206	£2.40
1302	70-71	71206	£2.40
T1/1303	72-79	71207	£2.40
T2	65-67	71210	£3.50
T2	68-69	71215	£3.50
T2	70-72	71217	£3.50
T2 LHD 1.6	73-79	71220	£3.50
T2 1.6	73-76	71223	£3.50
From Chassis No 213 2000 001 to 216 21000 001			
T2 1.6	76-78	71226	£3.50
T1 1.7-2.0	73-76	71235	£3.50
T2 2.0	76-79	71238	£3.50
T25 2.0	80-82	71244	£3.50
T1 (Acc Repair Kit)	65-79	71700	£6.25



## Heater Cables

Model	Year	Description	Part No	Gemo
T1	65-72	Heat Exchanger	74104	£3.00
1302	70-72	Heat Exchanger	74104	£3.00
T1	65-72	Rear Well	74105	£3.00
T1	73-79	Heat Exchanger	74107	£3.00
T1	73-79	Rear Well	74108	£3.00
1303	73-79	Heat Exchanger	74109	£3.00
T2	68-71	LH/RH	74120	£7.95
T2 1.6	72	LH/RH	74122/4	£7.95
T2 1.6	73-79	LH/RH	74126/8	£7.95
T2 2.0	73-79	LH/RH	74129/30	£7.95
T1 Bonnet Cable	68 ⇒		75100	£3.00

## Speedo Cables

Model	Year	Part No	Gemo
T1	⇒79	76105	£5.75
T1 LHD	⇒79	76104	£5.75
1302/3	70-79	76107	£5.75
1302/3 LHD	70-79	76106	£5.75
T2	⇒79	76112	£7.95
T1/2 Speedo Cable Circlip		76100	£0.10

## Handbrake Boot



Handbrake Boot 65-74

You can also place an order by emailing us at: [aircooled@gsfcarparts.com](mailto:aircooled@gsfcarparts.com)

Model	Year	Part No	Price
Handbrake Boot	65-74	73220	£5.40
Peddal Rubbers Brake/Clutch		73210	£0.60
Accelerator		73211	£2.50



### Technical Tips

Check the travel/free play of clutch/accelerator/handbrake pedals after fitting a new cable. The cables will stretch on initial use.

When fitting new cables always grease the cable and if possible inject grease into the cable guide tube to eliminate chaffing and cable failure.



cables

# bumpers



## Blade Bumpers

- T1 →67
  - T1 1.2 →73
  - Front/Rear Bumpers available all the same price
  - Brazilian Quality
- Front - 81305     £16.00  
Rear - 81400     £16.00



## Blade Bumpers - Stainless Steel

- Best Blade Bumpers available
  - Stainless Steel
  - High Quality Chrome finish
  - Will last years
  - Brazilian Quality
- Front - 81305B     £94.00  
Rear - 81400B     £94.00  
Over-riders - 81305D £7.60



## Blade Bumpers Towel Rail Style

- With Over-riders
  - T1 →67
  - T1 1.2 →73
  - Brazilian Quality
- Front - 81306     £37.50  
Rear - 81401     £37.50



## Europa Bumpers 68-74

- T1 1.3-1.6
  - Brazilian Quality
- Front - 81308     £18.50  
Rear - 81403     £18.50



## Europa Bumpers 75

- High Quality Chrome Finish
  - With Cut-Outs of Indicators
  - Brazilian Quality
- Front - 81311     £18.50  
Rear - 81405     £18.50



## Van Bumpers

- From 73-79
- Front - 81315     £45.00  
Rear - 81410     £45.00



## Van Bumpers 80-90

- Front - 81318     £34.50  
Rear - 81414     £28.50

## End Caps

- Front - 81550     £4.25  
Rear - 81552     £2.20

## Bumper Irons



Front /Rear Bumper Irons T1 →67 T1 1.2 →73 Front /Rear Bumper Irons T1 1.3-1.6 68-74

Model	Year	Front/Rear	Part No	Price
T1	→67	Front LH/RH	81500	£3.40
T1 1.2	→73	Front LH/RH	81500	£3.40
T1	→67	Rear LH/RH	81502	£3.40
T1 1.2	→73	Rear LH/RH	81502	£3.40
T1 1.3-1.6	68-74	Front LH/RH	81505/6	£4.25
T1 1.3-1.6	68-74	Rear LH/RH	81507/8	£4.25
T1 1.3-1.6	74	Rear LH/RH	81512/3	£12.45
1302/3	70-74	Front LH/RH	81510/1	£4.25
1302/3	70-74	Rear LH/RH	81512/3	£12.45
T1	75→	Front/Rear	81515	£6.25



bumpers

## Bumper Grommets



Grommet →67



Grommet 1.3-1.6 68-74

Model	Year	Part No	Price
T1	→67	81530	£0.60
T1 1.2	→73	81530	£0.60
T1 1.3-1.6	68-74	81532	£0.60
T1 1303 (Front)	74→	81535	£3.20
T1 1303 (Rear)	74→	81536	£2.00
Chrome Bolts (Europa Bumper)		81539	£0.60
Chrome Bolts (Blade Bumper)		81540	£0.60



1303 74→



Rear 68→ (not 1.2 →73)

## Running Boards

- High Quality Original
- Made in Germany
- Complete with fittings
- High Quality Rubber



Model	Year	Description	Part No	Price
T1	→67	LH German	86298	£28.50
T1	→67	RH German	86299	£28.50
T1	68-72	LH German	86302	£28.50
T1	68-72	RH German	86303	£28.50
T1	73→	LH German	86305	£28.50
T1	73→	RH German	86306	£28.50
T1	68→	LH Brazil	86300	£9.50
T1	68→	RH Brazil	86301	£9.50
T1	68→	Fitting Kit	86310	£1.85



### Technical Tips

When fitting repair panels and heater channels on a Beetle, do not disturb the rear seat support bar as this helps keep the body shape correct.

For German and Swedish or French Cars, call 0208 917 3801 for a free colour brochure!

**GSFCAR PARTS**

2004

quality parts and accessories for

citroen  
peugeot  
renault

www.gsfcarparts.com

**UP TO 70% OFF MRP**  
October 2004

**GSFCAR PARTS**

2004

quality parts and accessories for

audi  
bmw  
mercedes  
porsche  
saab  
volkswagen  
volvo

www.gsfcarparts.com











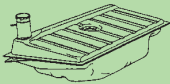







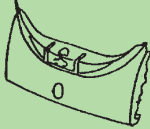

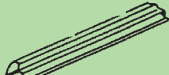
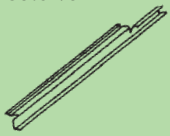
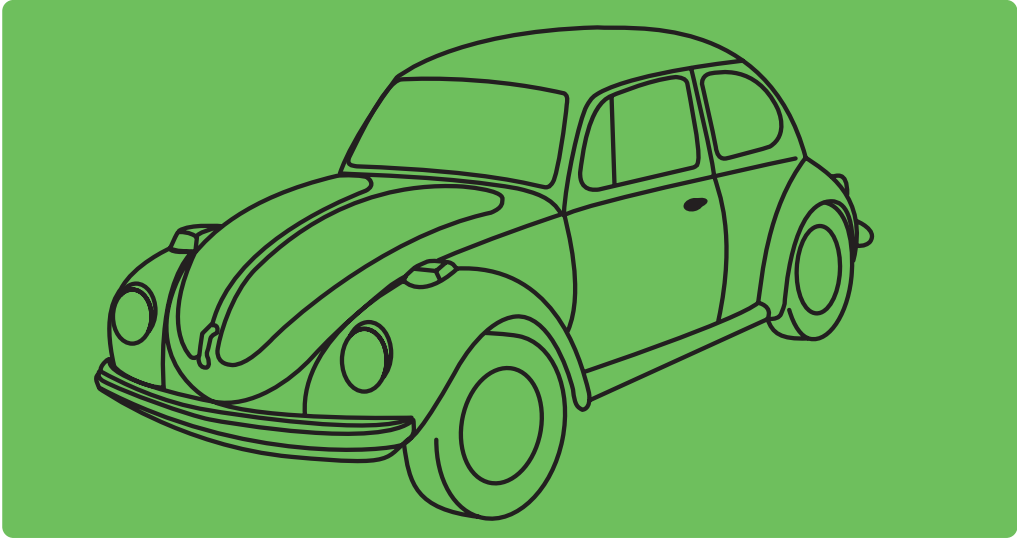











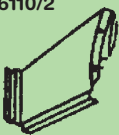

**UP TO 70% OFF MRP**  
September 2004

bumpers

# body repair panels

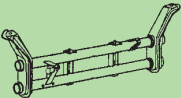
VW Type 1 Beetle (Not 1302/1303 Models)

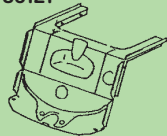
body repair panels

29309 	29310 	86126 	84580/A/B 		86070/1 
86130 	86135 	86144/5 	84522 	86108/9 	86100/1 
86102/3 					
86047/8 86030/1 					
86160/1 					
					
86148/9 	86170/1 	86104/5 	86140/1 	84520 	
86120 		84519 	86158/9 	86113/4 	86110/2 
86146/7 	86106/7 	86146/7A 	86123 		84530 
84583/4 	42200 	86040/2 86043/4 	86122 	86121 	86105C/D 

## VW Type 1 Beetle (Not 1302/3)

Description	Year	Part No	Price
Fuel Tank (Filler under Bonnet)	→67	29309	£36.00
Fuel Tank	68-79	29310	£36.00
Panel behind Pedal Cluster	→79	86126	£24.00
Rear Apron Panel	→66	84580A	£26.50
Rear Apron Panel	68-73	84580	£26.50
Rear Apron Panel	74-79	84580B	£26.50
Front Fitch Panel LH/RH	68 →	86070/1	£54.00
Battery Seat	→79	86130	£6.50
Jack Point Support	→79	86135	£8.70
Heater Channel End Plate LH/RH	→79	86144/5	£3.70
Front Apron Panel 1.3-1.5	68-74	84522	£18.50
Door Post LH/RH	→79	86108/9	£6.50
Sill Step LH/RH	→79	86100/1	£7.50
Running Board Mounting Plate LH/RH	→79	86102/3	£5.50
Rear Bumper Bracket Mounting LH/RH	→79	86170/1	£12.25
Rear Wing Mounting Plate LH/RH	→79	86148/9	£10.00
Heater Channel LH/RH	→67	86047/8	£42.50
Heater Channel LH/RH	69 →	86050/1	£42.50
Closing Panel LH/RH	→79	86104/5	£6.25
Inner Front Wing LH/RH (Large)	→79	86140/1	£7.25
Front Bumper Bracket Mounting LH/RH	68 →	86160/1	£12.25
Front Apron Panel 1.2	68-73	84520	£18.50
Spare Wheel Trough	→79	86120	£9.00
Front Apron Panel	→67	84519	£18.50
Front Bumper Mounting Bracket LH/RH	→67	86158/9	£12.25
Front Bumper Mounting Bracket LH/RH 1.2	→73	86158/9	£12.25
Bottom of Inner Door LH/RH	→79	86113/4	£8.25
Door to Wing Plate LH/RH	→79	86110/2	£8.50
Inner Rear Wing LH/RH 1.3/1.5 68B;1.2	74 →	86146/7	£16.25
Outer Bottom of Door LH/RH	→79	86106/7	£6.20
Inner Rear Wing LH/RH 1.2>73, T1	→67	86146/7A	£16.25
Frame Head Bottom Plate	→79	86123	£14.50
Front Axle Beam - LHD	66-79	42200	£85.00
Front Assembly 1.3/1.5	68-79	84530	£38.00
Door LH/RH	68 →	84583/4	£125.00
Front Axle Beam - Adj.LHD	66-79	42201	£85.00
Floor Pan LH/RH	→72	86040/2	£25.00
Floor Pan LH/RH	73 →	86043/4	£25.00
Frame Head	→79	86122	£42.50
Luggage Compartment Bottom	→79	86121	£42.50
Heater Channel Bottom Plate LH/RH	→79	86105C/D	£11.25
Front Floor Outer Section LH/RH	→79	86046A/B	£8.50
Rear Floor Outer Section LH/RH	→79	86046C/D	£8.50
Front Floor Half LH/RH	→79	86046E/F	£13.50
Rear Floor Half LH/RH	→79	86046G/H	£16.50
Inner Wing Repair Panel LH/RH	→79	86145A/B	£6.00



### Technical Tips

Prior to removing heater channels, place masking tape on the door pillars, marking the door opening. Use this measurement to ensure the door gap remains the same.



Front Bumper Bracket Mounting Panel



Front Inner Wing



Front Assembly



Rear Apron Panel 68-73



Rear Apron Panel →66



Panel Behind Pedal Cluster



Rear Wing Mounting Plate



Rear Bumper bracket Mounting Panel



Frame Head Bottom Plate



Inner Rear Wing 1.3/1.5 68 →



Inner Rear Wing 1.2 →73 T1 →67



Spare Wheel Trough



Front Apron Panel 1.3/1.5 68-74

















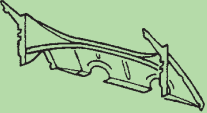

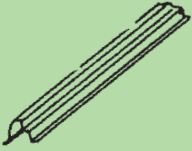
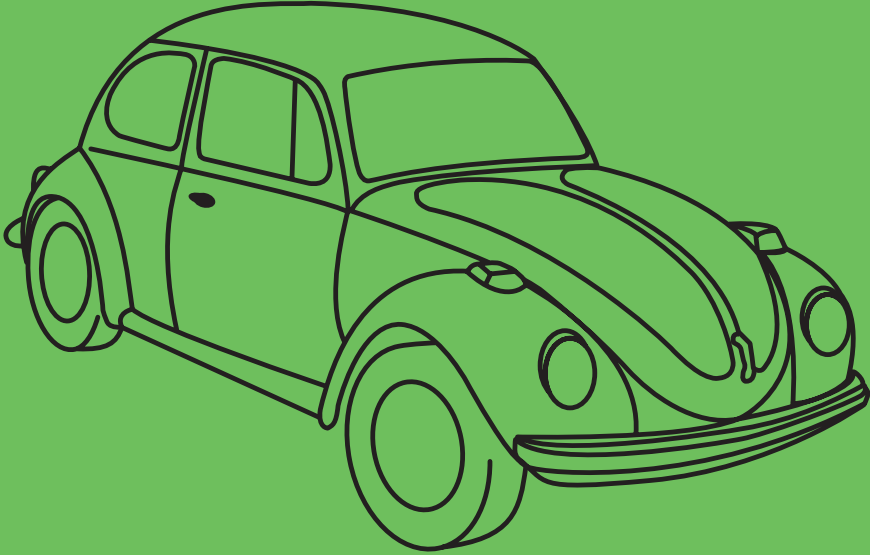

Front Apron panel 1.2 68-73

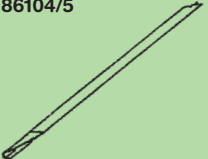
body repair panels

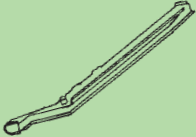
# body repair panels

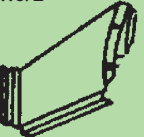
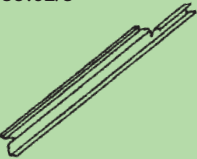
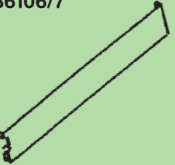
VW Type 1 Beetle 1302/1303 70-79

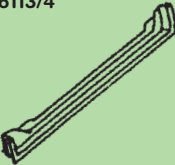
body repair panels

29311 	86130 	86135 	86144/5 	
84580B 	84523 	86164/5 	86108/9 	86100/1 
				
				86104/5 
				86148/9 
86142/3 	86055/6 	86146/7 	86110/2 	86102/3 
86106/7 			86113/4 	86045/6 



# VW Beetle 1302/1303 70-79

Description	Part No	Price
Fuel Tank (Filler under Bonnet)	29311	£47.50
Battery Seat	86130	£6.50
Jack Point & Support	86135	£8.70
Heater Channel End Plate LH	86144	£3.70
Heater Channel End Plate RH	86145	£3.70
Rear Apron Panel	84580B	£26.50
Front Apron Panel	84523	£18.50
Front Bumper Bracket Mounting LH	86164	£12.25
Front Bumper Bracket Mounting RH	86165	£12.25
Door Post LH	86108	£6.50
Door Post RH	86109	£6.50
Sill Step LH	86100	£7.50
Sill Step RH	86101	£7.50
Running Board Mounting Plate LH	86102	£5.50
Running Board Mounting Plate RH	86103	£5.50
Rear Wing Mounting Plate LH	86148	£10.00
Rear Wing Mounting Plate RH	86149	£10.00
Inner Front Wing Repair Panel LH	86142	£9.00
Inner Front Wing Repair Panel RH	86143	£9.00
Heater Channel LH	86055	£42.50
Heater Channel RH	86056	£42.50
Inner Rear Wing LH	86146	£16.25
Inner Rear Wing RH	86147	£16.25
Door to Wing Plate LH	86110	£8.50
Door to Wing plate RH	86112	£8.50
Closing Panel LH	86104	£6.25
Closing Panel RH	86105	£6.25
Bottom of Door - Outer LH	86106	£6.20
Bottom of Door - Outer RH	86107	£6.20
Bottom of Door - Inner LH	86113	£8.25
Bottom of Door - Inner RH	86114	£8.25
Floor Pan LH	86045	£35.00
Floor Pan RH	86046	£35.00
Bottom Plate Framehead	86124	£38.00
Bottom Plate Heater Channel LH/RH	86105E/F	£11.25
Body Fitting Bolt Pointed	86060	£0.50



## Technical Tips

When welding panels where distortion can occur, use the spot weld methods using a MiG welder. Work from the centre outwards. Between each weld allow the panel to cool, this will minimise the effects of distortion.



## Technical Tips

Before cutting out a rusted section, offer up the new panel and scribe round it, this will ensure that the repair panel will fit properly.



Front Apron Panel



Rear Apron Panel



Front Bumper Bracket Mounting



Jack Point  
Heater Channel End Plate



Door Post



Battery Seat



Bottom of Door Outer



Sill Step



Closing Panel



Bottom of Door - Inner



Heater Channel



Running Board Mounting Plate



Floor Pan



Beetle Door

body repair panels

# van repair panels

86212

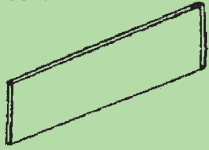

86213



84534/5

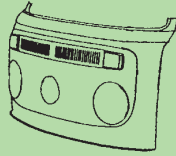

84537



84536



86216/7



86220/1



86214/5



86264/5



86240



86200/1

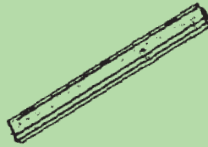

86208/9



84586

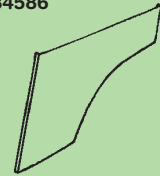

86260/1



86232



86233



86243/4



86245/6



86270

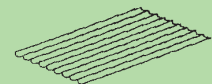

van repair panels

## Van Body Repair Panels 68-79

Description	Year	Part No	Price
Lower Sliding Door Skin	68-79	86212	£11.50
Lower Sliding Door Inner	68-79	86213	£11.50
Front Panel Half	68-72	84534	£32.00
Front Panel Half	73-79	84535	£48.50
Front Panel Inner	68-71	84537	£28.00
Front Panel Lower	68-79	84536	£19.95
Inner Sill LH/RH	68-79	86206/7	£11.95
Battery Seat	68-72	86230	£13.50
Battery Seat	71-79	86231	£13.50
Rear Corner Panel LH/RH	68-72	86216/7	£14.30
Rear Corner Panel LH/RH	73-79	86220/1	£19.50
Rear Wheel Arch LH/RH	68-79	86234/5	£18.25
Rear Wheel Arch LH/RH	68-72	86233B/C	£18.25
Rear Arch Panel Front LH/RH	73-79	86214/5	£6.50
Rear Jack Point LH/RH	68-79	86264/5	£13.25
Front Outrigger LH/RH	68-79	86240	£8.50
Sill opposite Sliding Door	68-79	86200	£5.85
Sill under Sliding Door	68-79	86201	£5.85
Inner Panel under Sliding Door	68-79	86202	£8.95
Outer Sill	→67	86200A	£9.50
Front Arch Complete LH/RH	73-79	86208/9	£43.80
Front Arch Complete LH/RH	68-72	86208/9B	£43.80
Door Skin LH/RH	69-79	84586/7	£27.50
Jack Point Front LH/RH	68-79	86260/1	£13.25
Front Crossmember	68-79	86232	£14.50
Rear Crossmember	68-79	86233	£14.50
Outrigger Centre LH/RH	68-79	86243/4	£8.50
Outrigger Rear LH/RH	68-79	86245/6	£8.50
Rep. Panel behind Front Wheel Arch LH	68-79	86224/5	£8.00
Universal Floor Plate	68-79	86270	£16.50
Sill Step LH/RH	68-72	86226/A	£8.50
Sill Step LH/RH	73-79	86226B/C	£8.50
Inner Panel behind Sliding Door	68-72	86203	£13.25
Inner Rail opposite Sliding Door	68-72	86204	£13.25
Front Section Front Wheel Arch LH/RH	68-72	86227/A	£9.80
Front Section Front Wheel Arch LH/RH	73-79	86227B/C	£9.80
Rear Section Front Wheel Arch LH/RH	73-79	86227D	£11.25
Chassis Rail Front	68-72	86231B	£14.50
Rear Wheel Arch Lower LH/RH	73-79	86235B/C	£5.50
Rear Panel Lower	73-79	86236	£11.25



Battery Seat



Rear Corner Panel 73-9



Front Panel



Front Arch - Complete



Rear Wheel Arch



Front Door Skin

van repair panels

## Opportunities at **GSFCAR PARTS**

“We always have vacancies for the right people”

With 42 branches and 2 major distribution centres in Birmingham and Heathrow the GSF Car Parts Group employs over 500 people nationwide and has over 200 delivery vehicles on the road.

We often require staff in all areas of our organisation, Sales, Purchasing, Delivery and Warehouse at our distribution centres, Sales and Delivery Drivers at our branches.

If you feel you would like to be one of us please get in touch.

Visit our website [www.gsfcarparts.com](http://www.gsfcarparts.com)

Email: [careers@gsfcarparts.com](mailto:careers@gsfcarparts.com)

or contact Dave Atkinson, GSF Car Parts Ltd, The Planet Centre, Armadale Road, Feltham, Middlesex TW14 0LW

# body panels



## Bonnets/Engine Lids/Doors - All Models

Number	Model	Year	Description	Part No	Price
1	T1	→67	Bonnet	84474	£149.00
2	T1 1.2	68→	Bonnet (no Air Inlet Grille)	84475	£54.00
	T1	68→	Bonnet (Air Inlet Grille)	84480	£54.00
3	T1/1302/3	68→	Rear Engine Lid	84581	£29.75
4	T1/1302/3	68→	Door LH/RH	84583/4	£125.00
	T1/1302/3		Engine Lid/Bonnet Seal Channel	86136	£2.50

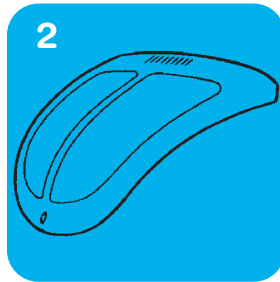
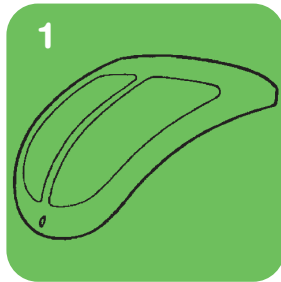

body panels

## Wing Fitting Kits



You can also place an order by emailing us at: [aircooled@gsfcarparts.com](mailto:aircooled@gsfcarparts.com)

Model	Part No	Price
Brazilian	84460A	3.50
Black Wing Beading	84461	1.80
White/Black Beading 25ft	99361	5.00

Remember GSF offer you the complete mail order service

- Express 24 hour delivery on the UK mainland (subject to postcode)
- Special delivery rates to the Scottish Islands, N.Ireland and Eire
- We export worldwide - goods fully insured - fast efficient service

## Wings



Front Wing T1 →67  
Sloping Head Lamp, no Bumper Iron Slot  
84300/1 £65.00



Front Wing T1 1.2 68-73  
No Horn Grille, Upright Headlamp, Indicator on Wing, no Bumper Iron Slot  
84304/5 £23.50



Front Wing T1 1.2 75→  
No Indicator Hole on Top, Long Slot for Bumper  
84306/7 £23.50



Front Wing T1 1.3/1.5 68-74  
Upright Headlight, Long Bumper Slot  
84310A/11A £23.50



Front Wing 1302/3 →73  
Curved at Front, Indicator on Wing  
84314/5 £58.00



Front Wing 1303 74→  
'D' Shaped Hole for Bumper  
84316/7 £58.00



Rear Wing T1 →67; T1 1.2 →73  
Small Rear Lamps, Small Slot for Blade Bumper  
84440A/1A £20.00



Rear Wing T1 1.3/1.5 68-73  
Small Rear lamps, Long Bumper Slot  
84442A/3A £20.00



Rear Wing T1 74→; 1303 73→  
Large 'Elephants Foot' Hole for Rear Lamps  
84444A/5A £20.00



Horn Grilles  
82200 £2.50

# body trim

## Bonnet Parts



Bonnet Handle 67



Bonnet Handle 68



Upper Bonnet Lock

Model	Year	Description	Part No	Price
T1	67	Bonnet Handle	87565	£4.50
T1	68	Bonnet Handle	87570	£4.50
T1	68	Bonnet Handle Seal (Upper/Lower)	87568/9	£0.25
T1	67	Bonnet Catch (Upper)	87566	£8.00
T1	67	Bonnet Catch (Lower)	87567	£8.00
T1	68	Bonnet Lock (Upper)	87571	£8.00
T1	68	Bonnet Lock (Lower)	87572	£8.00

## Door Handles/Locks



T1 Door Handle 68



T2 Door Handle 68



Ignition Barrel & Key 71

Model	Year	Description	Part No	Price
T1	68	Door Handle & Keys	87505	£8.75
T2	69-79	Door Handle & Keys	87510	£8.75
T25	80-90	Door Handle & Keys	87512	£41.50
T1/T2/T25	71	Ignition Barrel & Keys	92820	£7.50
T2	76	Engine Lid Hinge	87700	£10.00
T1	67-71	Engine Lid Lock & Keys	87550	£18.00
T1	72	Engine Lid Lock & Keys	87551	£18.00
T2	67 only	Engine Lid Lock & Keys	87550	£18.00
T2	70-79	Grab Handle (Inner)	87598	£3.50
T1	68	Glove Box Lock & Keys	87599	£8.25
T25	80-90	Steering Lock Housing	92830	£16.50



T1 Engine Lid Lock 67-71



T1 Engine Lid Lock 72



Van Grab Handle 70-79

## Window Winder Mechanisms/Handles

Model	Year	Description	Part No	Price
T1	68-74	Window Winder Mech LH/RH	87300/1A	£16.45
T1	75	Window Winder Mech LH	87302	£16.45
T1	75	Window Winder Mech RH	87303	£16.45
T2	68-79	Window Winder Mech LH/RH	87305/6	£16.45
T1/T2	71-75	Window Winder Handle	87351	£1.40
T1	68	Window Winder Screw	87380	£0.30
T1/T2/T25	75	Window Winder Handle	87352	£1.40
T1	68	Window Lift Channel	87345	£5.95
T1	68	Window Channel Seal	87346	£1.00
T25	80-90	Window Winder Mech RH	87315	£36.00

## Window Trim Frames/Catches

When fitting:

- Remove Quarter Light
- Be careful not to bend the frame
- Make sure the Window Rubber Scraper is flush to the door

Model	Year	Description	Part No	Price
T1	65	Window Frame Trim LH/RH	86637/8	£16.20
T2	68-79	Window Frame Trim LH/RH	86639/A	£19.50
T1	68	1/4 Light Catch LH/RH	87660/2	£4.60
T1	65	1/4 Light Seal LH/RH	87218/B	£9.50
T1	79	1/4 Light Seal Strip	87218D	£2.00
T1	68-79	Inner Window Scraper LH/RH	86633/4	£14.50
T2	68-79	Inner Window Scraper LH/RH	86635/6	£6.00
T1/T2	79	Wind/Channel Furflex Top Rear	87216	£9.50
T1/T2	79	Wind/Channel Furflex Front	87217	£4.25
T1	79	Interior Panel Clip	86590	£0.20
T1	79	Rubber Seal for above	86591	£0.20



## Interior Panel Set

- T1 68
- Includes 2 Front Door Panels
- With/without Pockets
- Padded/Strong backing
- Heat-seamed Pattern
- Pre cut for easy installation

87590 £28.50



## Headlining Kit

- Top Quality
- White - 88544 £36.00
- Black - 88545 £36.00

## Luggage Compartment Lining

87592 £14.50

## Chrome Hubcaps Genuine

- Top Quality Chrome
  - Fits all Beetles/Vans 68
  - Flat
- 45205 £13.40



## Spare Wheel Cover and Bracket

- Top Quality Cover
- Brazilian Quality
- Cover - 88612 £14.50
- Bracket - 88610 £12.50



# body trim

## Windscreen Seals



T1 Door Seals



Window Seals

Model	Year	Part No	Price
T1	66→	87220	£8.45
T1 - German quality	66→	87220B	£17.00
1303	72→	87221	£8.45
T2	68-79	87224	£21.50
T1	65→	87225	£9.00
Rear Quarter window rubbers LH/RH		87225	£9.00
T1 Chrome Trim for Windscreen per metre		86358	£7.00
Clips for above		86359	£1.60

## Rear Window Rubbers

Model	Year	Part No	Price
T1	65-71	87227	£9.00
T1	72→	87228	£9.00

## Bonnet/Engine Lid Seals

Model	Year	Part No	Price
T1-Brazilian	→79	87200	£4.50
1303	→79	87202	£6.25
T1 Engine Lid Seal	→79	87210	£1.50
T2 Engine Lid Seal	72-79	87211B	£21.50
T1 Number Plate Seal	67→	87212	£2.00

## Cal Look Rubber Sets

Kit Includes Front/Rear Seal and Rear Quarters

Model	Year	Part No	Price
T1	65-71	99835	£18.50
T1	72→	99837	£18.50
1303	72→	99840	£18.50

## Door Seals

Model	Year	Part No	Price
T1	→66	87203/A	£7.50
T1	67→ LH/RH	87205/6	£6.95
T1 German	67→ LH/RH	87205/6A	£14.60
T2	68-79 LH	87207	£9.75
T2	68-79 RH	87208	£9.75
T2 Sliding Door Seal	68-79	87209	£31.50
T1 Body Seal	→79	87214	£8.50

## Stoneguards

- Fits all Beetles
  - Top quality – easy to fit
  - Anodized Aluminium
  - Polished Chrome Surface
  - Made in Germany
- Pair - 86640      £8.50



## Beetle 9 Piece Chrome Trim Set

- Includes:
- 2 x Running Board Trim
  - 1 x Bonnet Trim
  - 3 x LH Body Trim
  - 3 x RH Body Trim

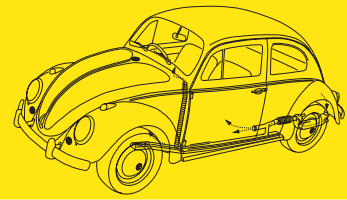

## Chrome Trim – Exterior 9 Piece Trim Sets

- All of our Chrome Trim is made in Germany
- Original Specification
- Original Quality

Model	Year	Description	Part No	Price
T1	→66	9 Piece Trim Set (34 Clips)	86350	£32.50
T1*	68-72	9 Piece Trim Set (70 Clips)	86352	£32.50
T1	→66	Trim clip	86600	£0.20
1303*	72→	9 Piece Trim Set (70 Clips)	86354	£32.50
T1	→66	Trim clip	86587	£0.30



You can also place an order by emailing us at: [aircooled@gstcarparts.com](mailto:aircooled@gstcarparts.com)

## Exterior Chrome Trim

- High Quality Chrome Finish
- Made in Germany
- Original Specifications

Model	Year	Description	Part No	Price
T1	68-72	Bonnet Air Intake	86620	£8.00
1303	72-79	Bonnet Air Intake	86621	£8.00
T1	→79	Above Engine Lid Trim	86622	£11.25
1303	72-79	Above Engine Lid Trim	86623	£11.25
T1	→79	Engine Lid (4 Piece)	86625	£15.00
T1	71→	Door Handle Finger Plate	86628	£6.50
T1	68→	Bonnet Handle Finger Plate	86629	£6.50



Bonnet Air Intake 1303



Bonnet Air Intake T1 68-72



Engine Lid Trim – 4 Piece



Door Handle Finger Plates



## Technical Tips

Smear inside of hubcaps with grease to prevent corrosion. Regularly wipe outside of hubcaps with light oil to prevent deterioration.

## Engine Lid Cowl

- High Quality
- Made in Germany
- Proper Bolt Fitting

86440 £21.50



## Mirrors

- High Quality Chrome Mirrors
- Made in Germany
- Original Specification

Model	Year	Part No	Price
T1-LH/RH	→67	99383	£21.00
T1 - LH	68-79	88205	£12.50
T1 - RH	68-79	88206	£12.50
T2 - LH	68-79	88210	£14.75
T2 - RH	68-79	88211	£14.75
T25 - LH	80-90	88220	£14.75
T25 - RH	80-90	88221	£14.75



## Interior Light



Model	Year	Description	Part No	Price
T1	68 →	Interior Light	95750	£4.25
T1	→79	Interior Light Switch (1 Pole)	93510	£1.60
T1	→79	Interior Light Switch (2 Pole)	93511	£1.80

## Seat Belts

- Original Quality
- Excellent Fit
- Includes all Fittings

Model	Year	Description	Part No	Price
T1	→79	Static Seat Belt	89000	£19.50
T1	66 →	Auto Seat Belt	89004	£25.00
T2	→79	Auto Seat Belt	89003	£28.00
T1	→79	Rear Seat Belt Static	89010	£16.50
T1	→79	Rear Seat Belt Auto	89012	£26.50



See pg 46 for details on how to order

## Miscellaneous

Model	Year	Description	Part No	Price
T1	→73	Horn Grille	82200	£2.50
T1	→79	Bonnet Badge Clip	86580	£0.35

## accessories

### Batteries

- Original Equipment
- Reliable Long Life
- 3 Year Warranty
- Made in Germany

Model	Volt	Year	Amps	GSF	Bosch
T1/T2	6 Volt	→67	66Amp	-	£43.50
T1	12 Volt	68 →	36Amp	£18.60	£28.50
T2/T25 12Volt		68 →	45Amp	£21.00	£34.00



**BOSCH**

### Tools



Model	Description	Part No	Price
Most	Jack	98550	£24.00
Most	Gearboxes Allen Key - 17mm	98710	£5.50
Most	CV Joints Splined Socket Set	98730	£6.30
Most	Socket 36mm 3/4 Drive	98750	£7.00
T2	Socket 46mm 3/4 Drive	98755	£10.00
Most	Sliding 3/4 Drive T-Bar	98770	£16.00
Most	Battery Booster Cables	98795	£7.95
Most	Flywheel Locking Tool	98775	£6.50

### Lubricants

Description	Part No	Price
Morris Supreme (5 Litre)	98000	£7.95
Morris Gearbox Oil 80w/90 (1 Litre)	98011	£2.60
Releasing Fluid Aerosol	98015	£2.75
Morris CV Joint Grease (500ml)	98020	£2.40
Morris Multi Purpose Grease (500ml)	98022	£2.40
Hylomar (Tube)	98050	£5.00
Exhaust Paste (Tube)	98055	£3.50
Brake Cleaner (Aerosol)	98057	£3.50
Carburettor Cleaner (Aerosol)	98059	£4.75
Screenwash (600ml)	N98075	£0.90
De-icer (Aerosol)	98077	£0.85
Morris Brake Fluid (5 Litre)	98100	£14.00
Morris Brake Fluid (1 Litre)	98101	£3.50
Morris Brake Fluid (500ml)	98105	£2.50
Flushing Oil (5 Litre)	98003	£7.95
Latex Gloves (Medium/Large) pack 100	N98200/2	£2.75
Chamois Leather	98170	£3.50

body trim/accessories



# lighting

## Headamps

- Original Quality
- Made in Germany
- Hella – One of Europe's largest suppliers



## Beetle/Van 68-73

- Manufactured by Hella
- Made in Germany
- Comes complete with Reflector, Rim & Lens
- 3 Fixing Bolts in Chrome
- This Lamp fits all Beetles and Vans from 68-73
- To fit Van Models turn the Chrome Rim around



Headlamp - 94200 £52.00  
Lens - 94800 £7.25

## Beetle/Van 74

- This Lamp fits all Beetles and Vans from 74-79
- This is a sealed unit (No Seperate Lens), one Fixing Bolt on the Rim and a Flat Glass Lens



Hella - 94203 £21.00  
Alt - 94302D £11.50

## Van 80-90

- Fits all Models
- 94204 £25.00

## Headlamp Eyebrows

- Fits all Beetles and Vans
- 99880 £6.50



## Headlamp Rims



T1 →67      T1/T2 68-73 – 3 Bolt      T1/T2 74 → 1 Bolt

Model	Year	Part No	Price
T1	→67	94849	£7.45
T1/T2 - 3 Bolt	68-73	94850	£7.45
T1/T2 - 1 Bolt	74-79	94851	£7.45
Headlamp Rim Screw	-	94854	£1.00

## Indicator Lamps



T1 – Indicator – on Wing 66-74



T1 75 → in Bumper

Model	Year	Description	Part No	Price
T1	66-74	On Wing	95300	£6.50
T1	75 →	In Bumper	95304	£6.50
T25	80-90	Indicator Lens	95317/9	£8.25

## Rear Lamp - Beetle



Beetle →67; 1.2 →73



T1 68-73

Model	Year	Lamp/Lens	Part No	Price
T1	62-67	Lamp	95492/3	£17.50
T1 1.2	→73	Lamp	95492/3	£17.50
T1	62-67	Lens	95500	£4.00
T1 1.2	→73	Lens	95500	£4.00
T1 1.3 - 1.6	68-73	Lamp	95502/3	£17.50
T1 1.3 - 1.6	68-73	Lens	95504	£4.00
T1 1303;T1	74 →	Lamp	95508	£12.00
T1	74 →	Smoked Lamp	95508S	£12.00
T1 1.2	→73	Seal	87275	£3.00
T1 1.3/1.5	68-73	Seal	87276/7	£4.20



T1 74 →; 1303



Vans Lens 62-71

## Rear Lamp - Van



Van Lens 72-79



Van Lamp Complete 72-79

Model	Year	Lamp/Lens	Part No	Price
T2	62-71	Lens	95511	£6.50
T2	72-79	Lamp Complete	95512	£14.50
T2	72-79	Lamp Smoked	95512A	£14.50
T2	72-79	Lens	95513	£6.50



## Technical Tips

When fitting new lenses, do not over tighten the screws or the lens will crack. Tighten them up until the lamp seat in, then 1/4 turn to finish.



# ignition

## Distributors

- Bosch 009 Distributor
  - Centrifugal fits most Models T1/T2 1.6 →79
  - This unit does away with the Vacuum Unit
- 92010      £46.50



## Distributor Vacuum Unit



**BOSCH**

Model	Year	Description	Part No	Price
T1 1.2/1.3/1.5	67-70		92412	£14.50
T1/T2 1.3-1.6	71-72	2 Screw Fixing	92410	£14.50
T1/T2 1.3-1.6	73-79	4 Screw Fixing	92415	£14.50

## Distributor Caps



**BOSCH**

Model	Year	Part No	Price
T1/T2	64-68	92120	£3.80
T1/T2/T25	69→	92130B	£3.80

## Ignition Leads

- Complete Set of 4 Leads plus Ignition Coil Lead

Model	Year	Origin	Part No	Price
T1/T2 1.2-1.6	→79	German	92600	£6.25
T1/T2 1.2-1.6	→79	Brazilian	92601	£4.00
T2/T25 1.7-2.0	→82	German	92604	£11.25



You can also place an order by emailing us at: [aircooled@gsfcarparts.com](mailto:aircooled@gsfcarparts.com)

## Rotor Arms



Governed Rotor Arm



Rotor Arm – most 69→

Model	Year	Description	Part No	Price
T1/T2	64-68	Standard	92202	£2.50
T1/T2/T25	69-82	Standard Large Spline	92205	£2.50
T2 1.6	71-79	Governed	92250	£7.50
T2/T25 1.7-2.0	→82	Governed	92255	£7.50

## Contact Points



Points 64-68



69-70



70→

Model	Year	Part No	Price
T1	64-68	92353	£2.50
T2	64-67	92353	£2.50
T1/T2	69-70	92355	£2.50
T1/T2	70→	92360	£1.50

## Condensors



T1 64-72; T2 64-70



T1 73→

Model	Year	Part No	Price
T1	64-72	92300*	£3.00
T2	64-70	92300*	£3.00
T2	71-73	92302	£3.00
T1/T2	73→	92304	£3.00
T2/T25	74→	92304	£3.00

\*Round Connector

## Ignition Coils



12v Bosch 'Blue' Coil



6 Volt Ignition Coil

Model	Year	Voltage	Part No	Price
T1/T2	→68	6 Volt	92500	£21.50
T1/T2	→79	12 Volt	92511	£9.95
T1/T2 (Blue Coil)	→79	12 Volt	92510	£14.00

## Spark Plugs

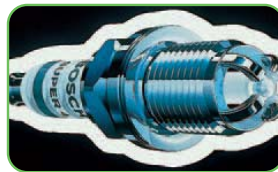

**BOSCH**

Model	Year	Type	Price
T1/T2 1.2-1.6	→79	W8AC	£0.95
T2/T25 1.7-2.0	→82	W8CC	£0.95

## Spark Plug Connectors



Short Plug Connector



Long Plug Connector

Model	Year	Description	Part No	Price
Most Models	→79	Short Plug Connector	92660	£0.80

# electrical



## Starter Motors

- High Quality Recon Units
- Full One Year Warranty
- Computer Tested
- Units Include Solenoid



Model	Year	Part No	Swedish	Bosch
T1 6 Volt	→66	90100	£75.00	-
T1 6 Volt	67→	90102	£75.00	-
T1	68→	90104/5	£47.50	£62.50
T2	67-75	90104/5	£47.50	£62.50
T1/T2 Auto	→79	90108	£76.00	-
T2/T25	76-81	90110	£56.00	-
T25	81-86	90115	£64.00	-
T1/T2 12 Volt	→79 Starter Bush	90103	£0.70	-
T1 688;T2	→75 Starter Solenoid	90106	£15.75	-

## Generators\*

- High Quality Recon Units
  - Full One Year Warranty
  - Computer Tested
- \*Also known as a Dynamo



Model	Year	Volt	Part No	Price
T1 1.2/1.3	→66	6 Volt	90300	£110.00
T1	67→	6 Volt	90302	£76.00
T1	→79	12 Volt	90306	£56.00
T1 (Bosch)	→79	12 Volt	90305	£85.00
T2 1.6	69→		90310	£78.00

## Alternators\*

- High Quality Recon Units
- Full One Year Warranty
- Computer Tested

\*As a general rule models after 1973 are fitted with an alternator



Model	Year	Amp	Part No	Price
T1/T2	→74	50 Amp	90315	£74.50
T1/T2	75-79	55 Amp	90320	£74.50
T1/T2 (Bosch)	75-79	55 Amp	90319	£74.50
T2 1.7 - 2.0	→79		90330	£85.00

## Indicator Switches



T1 72→ Plug Fitting



T2 74-79

Model	Year	Part No	Price
T1	68-70	93361	£25.00
T1 (9 Wire Fitting)	71→	93362	£26.50
T1 (Plug Type Fitting)	72→	93363	£26.50
T2	73-74	93366	£34.50
T2	74-79	93367	£21.50
T25	80-90	93368	£18.50

## Generator/Alternator Parts



Alternator Pulley



Generator Brushes



Alt/Generator Stand

Model	Year	Description	Part No	Price
T1/T2	67→	12v Pulley Gen/Alt	90805	£5.00
T1/T2	67→	12v Pulley Gen/Alt - Genuine	90806	£15.00
T1/T2	→79	Belt - Generator	13300	£2.50
T1/T2	→79	Belt - Alternator	13303	£3.50
T1/T2	→79	Pulley Shim	90820	£0.30
T1/T2	→73	Generator Brushes	90700	£3.50
T1/T2 1.2 -1.6	→79	Alt/Gen Stand	99107	£14.00
T2 1.7-2.0	→79	Belt - Alternator	13343	£2.50
T25 1.6/2.0	80-82	Belt - Alternator	13312	£3.50

## Regulators



T1 6 Volt → 67



T1 68→



Van 1.6 69-73

Model	Year	Description	Part No	Price
T1/T2	→67	7v 45 Amp	91010	£28.50
T1	68→	30 Amp - Generator	91018	£19.50
T2	67-68	14v 30 Amp - Generator	91018	£19.50
T2 1.6	69-73	14v 38 Amp - Generator	91020	£30.00
T1/T2→1.6	→74	For Bosch Alternator	91022	£25.00
T1/T2→1.6	75-79	For Bosch Alternator	91024	£19.00
T2 1.7- 2.0	→82	For Bosch Alternator	91026	£13.50

## Wash/Wipe Switches



T1 - Dash Fitted Switch



T1 74→



T1 72-74

Model	Year	Description	Part No	Price
T1	62-67	Fitted on Dash	93300	£22.00
T1	68→	Fitted on Dash	93301	£22.00
T1 Deluxe	68-71	Fitted on Dash	93301	£22.00
T1	72-74	Fitted on Column (5 Terminals)	93302	£28.50
T1	74→	Fitted on Column (6 Terminals)	93303	£36.00
T2	68-72	Fitted on Dash	93300	£22.00
T2	74-79	Fitted on Column	93305	£39.00
T25	80-90	Fitted on Column	93306	£17.50



## Ignition Switches



T1/T2 68-71

T1 58-67

T1/72 74

Model	Year	Part No	Price
T1	58-67	92800	£16.50
T1/T2	68-70	92801	£29.00
T1	71 Only	92802	£19.00
T2	71-74	92802	£19.00
T1	72-74	92803	£9.25
T1/T2	74	92804	£5.50
T1	68-69	92818	£10.00
T1/T2/T25	71-90 Barrel & key	92820	£7.50

## Miscellaneous Switches

Model	Year	Description	Part No	Price
T1/T2/T25	82	Oil Pressure Switch	93440	£2.00
T1/T2/T25	82	Brake Light Switch	93550A	£3.50
T1	71	Headlamp Switch	93400	£19.50
T1/T2	79	Reverse Light Switch	93460	£3.95
T25	88	Reverse Light Switch	93465	£4.45

## Electrical Relays

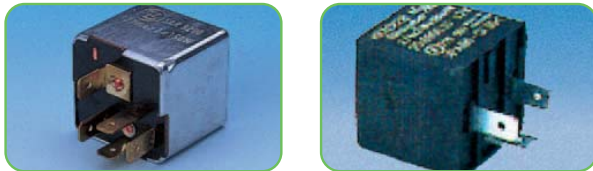

Headlamp Relay 71

Indicator Relay 71

Model	Year	Description	Part No	Price
T1/T2/T25 (3 Pin)	71-90	Ind/Eng Relay	93576	£5.00
T1/T2 (3 Pin)	71-79	Headlamp Relay	93565	£9.75

## Horns

Horn 6v - 93660 £9.75  
Horn 12v - 93631 £6.00



## Electrical Fuel Components



Fuel Tank Sender

T1 Fuel Gauge

Model	Year	Description	Part No	Price
T1/1302/3	68	Fuel Gauge	93650	£32.50
T1	68	Stabilizer	93680	£28.50
T2	73-79	Stabilizer	93680	£28.50
T1	68	Fuel Tank Sender	93690	£24.50
1302/3	70-79	Fuel Tank Sender	93691	£24.50
T2	73-79	Fuel Tank Sender	93693	£27.50
T25	80-90	Fuel Tank Sender	93694	£19.00
Most models	-	Sealing Ring	93699	£1.80

\*It is recommended to fit the Stabilizer when fitting a Fuel Gauge.

## Wiper Blades

- Original Equipment
- Twin Blade for greater performance

Model	Year	Size	Part No	Price
T1	65	11"	WB11	£2.50
1303	72	15"	WB15	£2.95
T2	68-79	16"	WB16	£2.95
T25	80-90	18"	WB18	£3.25



**BOSCH**

## Wiper Arms

- Please check your Spindle fitting – either Grub Screw or Nut Type



Model	Year	Description	Part No	Price
T1	65-67	Grub Screw Fit	93881	£12.50
T1	68-69	Grub Screw Fit	93882/3	£12.50
T1 Deluxe	70-72	Nut Type	93884	£12.50
1302	70-72	Nut Type	93884	£12.50
T1 Standard	73	Grub Screw Fit	93886	£12.50
T1 Deluxe	73	Nut Type	93888/9	£12.50
T2	69-79	-	93894	£12.50

## Miscellaneous Parts



T1 Washer Jets

You can also place an order by emailing us at: [aircooled@gstcarparts.com](mailto:aircooled@gstcarparts.com)

Model	Year	Description	Part No	Price
T1	-	Washer Jet	93775	£3.00
T2	68	Washer Jet	93776	£3.00
T25	80-90	Heater Fan	93497	£59.50
T1,T2,T3,T4	-	Elec Wiper/Washer Kit	93770	£29.95

## Wiper Motors



T1 70-71 Built in terminals

T1 72

Model	Year	Part No	Price
T25	80-90	93810	£39.00

## Aerials

- Fits All Beetles 57° angle
- 89200 £4.50



## Haynes Manual

98402 From £13.75

electrical



## Engine Parts



Crank Pulley

Oil Pressure Kit

Oilcap

Model	Year	Description	Part No	Price
T1/T2 1.2-1.6	→79	Crankcase Breather Kit	99113	£18.50
T1/T2 1.2-1.6	→79	Oil Pressure Boost Kit	99114	£3.75
T1/T2 1.2-1.6	67-70	Oil Pump Heavy Duty	99118	£18.50
T1/T2 1.2-1.6	71→	Oil Pump Heavy Duty	99119	£18.50
T1/T2 1.2-1.6	→79	Oil Filter Breather	99120	£7.25
T1/T2 1.2-1.6	→79	Oil Filler Cap Chrome	99122	£2.85
T1/T2 1.2-1.6	→79	Oil Filler Chrome & Tube	99124	£6.00
T1/T2 1.2-1.6	→79	Oil Filler Chrome	99123	£6.00
T1/T2 1.2-1.6	→79	Sump Plate Chrome	99125	£4.60
T1/T2 1.2-1.6	→79	Alt/Gen Stand Aluminium	99107	£14.00
T1/T2 1.2-1.6	→79	Alt/Gen Stand Chrome	99108	£16.50
T1/T2 1.2-1.6	→79	Sound Absorber Kit	99146	£19.50
T1/T2 1.2-1.6	→79	Oil Filler Vented	99126	£8.50
T1/T2 1.2-1.6	→79	Billet Crank Pulley Black	99149	£19.50
T1/T2 1.2-1.6	→79	Billet Crank Pulley Blue	99150	£19.50
T1/T2 1.2-1.6	→79	Billet Crank Pulley Red	99151	£19.50
T1/T2 1.2-1.6	→79	Crank Pulley Black	99152	£3.25
T1/T2 1.2-1.6	→79	Crank Pulley Nut Chrome	99156	£3.95
T1/T2 1.2-1.6	→79	Dyn_pulley Nut Chrome	99158	£8.00
T1/T2 1.2-1.6	→79	Engine Hardware Kit	99199B	£14.50
T1/T2 1.2-1.6	→79	Chrome Dipstick	99121	£3.50

For Big Bore piston and barrel kits see page 11



Oil Filler - Vented

Crank Pulley

Alt/Generator Stand

## Performance Air Filters



Flat Air Filter

Air Filter Pod Type

Model	Year	Description	Part No	Price
T1/T2 1.2-1.6	→79	Air Filter 165mm Chrome	99176	£8.45
T1/T2 1.2-1.6	→79	Air Filter 135mm Chrome	99178	£8.45
T1/T2 1.2-1.6	→79	Air Filter Pod Type 56mm	99179	£8.45
T1/T2 1.2-1.6	→79	Air Filter Pod Type 64mm	99179B	£8.45



## Tinware



Rocket Cover Aluminium

Cyl Head Shroud

Rocker Cover Chrome

Model	Year	Description	Part No	Price
T1/T2 1.2-1.6	→79	Rocker Cover Chrome	99115	£13.50
T1/T2 1.2-1.6	→79	Rocker Cover Alum Bolt	99117	£17.50
T1/T2 1.2-1.6	→79	Eng Tinware Front Chrome	99127	£16.60
T1/T2 1.2-1.6	→79	Rear Engine Tray Chrome	99128	£16.60
T1/T2 1.2-1.6	→79	Cyl Shroud T/Port Black	99129	£19.00
T1/T2 1.2-1.6	→79	Cyl Shroud T/Port Chrome	99130	£19.00
T1/T2 1.2-1.6	→79	Breast Plate Chrome	99132	£7.50
T1/T2 1.2-1.6	→79	Coil Cover/Bkt Chrome	99140	£3.70
T1/T2 1.2-1.6	→79	Generator Cover Chrome	99141	£5.00
T1/T2 1.2-1.6	→79	Alt Back Plate Chrome	99142	£5.00
T1/T2 1.2-1.6	→79	Generator Strap Chrome	99144	£2.50
T1/T2 1.2-1.6	→79	Louvered Firewall (3 Piece)	99145	£27.50
T1/T2 1.2-1.6	→79	Engine Dress Up Kit	99147	£42.00
T1/T2 1.2-1.6	→79	Louvered Fanbelt Guard	99148	£12.00
T1/T2 1.2-1.6	→79	Fanbelt Guard Mesh	99148A	£12.00
T1/T2 1.2-1.6	→79	Fan Housing Doghouse	99110	£45.00



Generator Strap

Fanbelt Guard Mesh

Louvered Fanbelt Guard

## Fuel Systems

Model	Year	Description	Part No	Price
T1/T2 1.2-1.6	→79	Petrol Pump Block-Off	99021	£3.50
T1/T2 1.3-1.6	→79	Weber Progressive Carb	18105	£275.00
T2 1.7-2.0	→79	Weber Progressive Carb	18107	£285.00

Kit comprises of Carb, Custom Manifold - for both Single/Twin Port and Air Filter.

## Electrical



Distributor Caps

Coloured HT Leads

Model	Year	Description	Part No	Price
T1/T2 1.2-1.6	→79	Ignition Leads Yellow	99180	£6.00
T1/T2 1.2-1.6	→79	Ignition Leads Blue	99181	£6.00
T1/T2 1.3-1.6	→79	Ignition Leads Red	99182	£6.00
T1/T2	→79	Distributor Cap Clear	99183	£4.50
T1/T2	→79	Distributor Cap Red	99184	£4.50
T1/T2	→79	Distributor Cap Blue	99185	£4.50
T1/T2	→79	Distributor Cap Gold	99186	£4.50
T1/T2	→79	Distributor Cap Smoked	99187	£4.50
T1	→67	Wiper Conversion 6v-12v	99354	£28.50
T1/T2	-	Alternator Conversion Kit	99100	£139.50

## Suspension



Lowered Shocks-Front



Sway Aways



Coil Over Shocks

Model	Year	Description	Part No	Price
T1	→79	Lowered Front Shocks pair	99310	£32.00
T1	→79	Front Coil Over Shocks	99311	£39.00
T1	→79	Rear Coil Over Shocks	99313	£39.00
T1	→79	Caster Shims	99316	£6.50
T1	→79	Caster Shim Long Bolts	99317	£3.20
T1	→79	Spring Plate Caps S/Axle	99319	£10.00
T1/1302/3	→79	Spring Plate Caps IRS	99320	£13.60
T1	→67	Sway Aways King Pin	99406	£11.15
T1	66-79	Sway Aways Ball Joint	99405	£11.15
T1	66-79	Front Axle Beam Adj LHD	42201	£85.00

## Interior Parts



Handbrake Lever



Gearlever Triggers

Model	Year	Description	Part No	Price
T1/T2	→79	Quickshift Gear Linkage	99324	£4.50
T1/T2	→79	Gearlever Trigger Short	99326	£37.50
T1/T2	→79	Gearlever Trigger Long	99327	£37.50
T2	60-79	Gearlever Trigger	99328	£54.00
T1	→79	Gearlever T-Handle Angled	99329	£37.50
T1	→79	H/Brake Lever Chrome	99332	£24.00
T1/T2	→79	3 Piece Pedal Covers	99335	£7.25
T1	→79	Billet Door Lock Pulls	99336	£4.00

## Body Parts

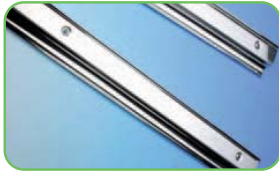

Chrome Sill Plates



Eng Lid Stand Off

Model	Year	Description	Part No	Price
T1	→79	Door Sill Covers	99356	£13.50
T1	→79	Wing Beading Black 25ft	99360	£5.00
T1	→79	Wing Beading White 25ft	99361	£5.00
T1-Blade	→73	T-Bars Chrome pair	99330	£12.50
T1-Europa	68-79	T-Bars Chrome pair	99331	£12.50
T1/1302	→79	Bonnet Strut Kit	99371	£18.50
T1	→79	Engine Lid Stand Offs	99374	£9.50
T1	→79	One Piece Window Kit Clear	99380	£56.00
T1	→79	Seals/Clips for above	99381	£16.00



Chrome T-Bars



Bonnet Strut Kit



1 Piece Window Kit

## Cal Look Window Rubber Sets

Model	Year	Description	Part No	Price
T1	65-71	Window Rubber Set	99835	£18.50
T1	72-79	Window Rubber Set	99837	£18.50
1303	→79	Window Rubber Set	99840	£18.50

Kits includes Front, Rear and Rear Side Rubbers

## Lighting



Smoked lamp T1 74→



Headlamp



T2 Smoked Rear Lamp

Model	Year	Description	Part No	Price
T1	→67	Headlamps (US Spec)	99350	£20.00
T1	-	H/lamp Unit for above	99351	£10.00
T1/T2	74→	Rear Lamp Smoked	99508S	£12.00
T1	72-79	Rear Lamp Smoked	99512A	£14.50



### Technical Tips

#### Removing and Installing an Engine

1. Always attach identifying tags to all wires, plugs etc. before disconnecting.
2. Quickly pull off fuel hose and clamp it quickly to avoid fire risk.
3. When installing the engine put transmission into gear, put handbrake on, then hand turn the crankshaft until splines mesh.



### Technical Tips

Engine Firing Order 1-4-3-2



# Opportunities at **GSFCAR PARTS**

“We always have vacancies for the right people”

If you feel you would like to be one of us please get in touch by visiting our website at [www.gsfcarparts.com](http://www.gsfcarparts.com), email: [careers@gsfcarparts.com](mailto:careers@gsfcarparts.com) or contact Dave Atkinson, GSF Car Parts Ltd, The Planet Centre, Armadale Road, Feltham, Middlesex TW14 0LW



# index

## a

Aerials	35
Air Filters	7
Alternators	34
Anti-roll Bars/Fitting Kits	13
Apron Panels	22-27

## b

Ball Joints	13
Batteries	31
Bearings - Engine	5
Body Panels	22-28
Body Seal	30
Bonnets	28
Bonnet Air Intake Trim	30
Bonnet Badge	31
Bonnet Finger Plates	30
Bonnet Handle	29
Brake Backing Plates	17
Brake Calipers	17
Brake Discs/Drums	16
Brake Fitting Kits	17
Brake Hoses	18
Brake Light Switch	35
Brake Pads/Shoes	16
Brake Pipe Kits	18
Bumpers/Irons/Mountings	20
Bump Stops	13

## c

Cables	19
Cal Look Rubber Kits	37
Cal Look	36-37
Camshaft/Cam Followers	5
Carburettor/Repair Kits	8
Choke Element	8
Chrome Trim Set	30
Clutches/Friction Plates/Release Bearing	9
Condensers	33
Contact Points	33
Crankcase/Stud Set	4
Crankshaft/Pulley	5
CV Joints/Boot Kits	14
Cylinder Heads	4

## d

Disc Brake Conversion Kit	18
Distributor/Caps	33
Distributor Drive Gear	5
Distributor Vacuum Unit	33
Door/Door Hinges	28
Door Handles/Finger Plates	29
Door Seals	30
Drag Link	15
Dynamo	34

## e

Engines	4
Engine Lid Cowl/Trim	31
Engine Lid Lock/Keys	29
Engine Mountings	7
Exhaust/Fittings Kits	10-12
Eyebrows	32

## f

Fanbelts	7
Floor Pans	22-27
Flywheel	5
Foam Engine Surround	7
Front Axle Beam	13
Front Panel	22-28
Fuel Filter	8
Fuel Gauge	35
Fuel Pump/Pedestal	8
Fuel Tank/Sender	8/35

## g

Gasket Sets	4
Gearbox Mounting/Gearbox Seal	7
Gearshift Coupling Kit	7
Generator/Bushes	34
Gland Nut	5
Glove Box Lock/Catch	29

## h

Headlamps/Rims	32
Headlamp Relay/Switch	35
Heat Exchanger	10-11
Heater Channels	22-27
Heater Hose	6
Horn Grille	31
Hubcaps	29
Hub Seal/Kits	14

## i

Ignition Barrel & Key	29
Ignition Coil	33
Ignition Leads	33
Ignition Switches	35
Indicator Lamps	32
Indicator Switches	34
Interior Panel Set	29

## j

J-Tubes	10
---------	----

## k

King Pin Kits	13
---------------	----

## l

Lever Kits - Heat Exchanger	11
Link Pin Kits	13

## m

Master Brake Cylinders/Repair Kits	17
Mirrors	31

## o

Oil Change Kit/Strainer	4
Oil Cooler	6
Oil Filler Cap/Oil Filter	7
Oil Pressure Switch	35
Oil Pump	6
Oil Seal - Crankshaft	5

## p

Petrol Tanks/Caps	8
-------------------	---

Piston & Barrel Sets/Big Bore Kits	4-5
Piston Rings	5
Pulley - Gen/Alt	34
Push Rod Tubes/Seals	6

## q

Quarter Light Catch	29
Quarter Light Seal	29

## r

Rear Lamps	32
Regulators	34
Repair Panels	22-27
Reverse Light Switch	35
Rocker Cover/Clip	4
Rotor Arms	33
Rubber Seals	30
Running Boards	21

## s

Seat Belts	31
Shock Absorbers	14
Spark Plugs	33
Speedo Cables	19
Sports Exhausts	12
Stand - Alt/Gen	34
Starter Motors	34
Steering Boxes/Couplings	15
Steering Dampers	15
Steering Knuckles	13
Stone Guards	30
Sway Aways	13
Swivel Pin Kits	15

## t

Tailpipes	10-11
Thermostat	7
Tie Rod/Tie Ends	15
Timing Gear	5
Tools	31

## u

Universal Joint	15
-----------------	----

## v

Valves/Guides	6
---------------	---

## w

Wheel Bearings	14
Wheel Bolts	16
Wheel Cylinders	18
Window Frame Trim	29
Window Lift Channel/Seal	29
Window Winder Handles	29
Window Winder Mechanisms	29
Windscreen Seals	30
Wings	28
Wiper Blade/Arm/Motor	35



# vehicle identification

Beetle  
67



- Sloping front wings and Headlamp
- Narrow blade bumper
- Small rear lamp
- Front Indicator on the wing

Beetle  
68-73



- Upright headlamp and wing
- 1.3-1.6 models fitted with Europa bumper
- Tombstone shape rear lamp
- Front indicator on wing

Beetle  
74



- Indicators in the bumper 75
- Europa bumper with indicator 75
- Headlamp has one fixing, with sealed beam
- Rear lamp elephants foot type 75

1302  
71-72



- Rounded front shape with short bonnet
- Flat windscreen
- Strut inserts fitted on the front
- Tombstone shape rear lamp

1302  
73



- Curved windscreen
- Elephants foot rear lamp
- Indicator in the bumper 75
- Rounded front shape with short bonnet

Van  
67



- Split front windscreen
- Small rear lamps
- Engine vents centre rear quarter
- Round front indicators

Van  
68-71

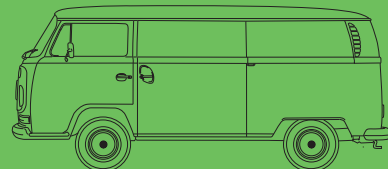

- Bay window front windscreen
- large rounded bumpers
- Engine vents upper rear quarter
- Small rear lamps

Van  
72-79



- Bay window front windscreen
- Large square section bumpers
- Large rear lamps
- Front indicators above headlamps

# how to order

## mail order

Using the German Swedish & French mail order service ensures you receive your order quickly and efficiently – without any hassle.

**However please remember to give us the correct information about:**

- Yourself
- Your vehicle
- Your payment card

> Order by 6.00pm Monday-Friday to receive your order within one working day (UK only, depending on postcode).

> If a part is not in stock we will inform you immediately and obtain the part as quickly as possible.

## you can order by...



mail

German Swedish & French,  
The Planet Centre,  
Armadale Rd, Feltham,  
Middlesex, UK TW14 0LW

phone



020 8917 3803

Also available from Glasgow, Dublin and Belfast

## export

Our export staff will advise you on the best way to despatch your order.

Please note residents of the EU must pay VAT unless they can provide a VAT registration number.

You can be assured that your order will be correctly picked and checked. We also insure all goods going overseas in case of loss or damage.

**phone** 00 44 20 8917 3895

**fax** 00 44 20 8818 0099

**email** [aircooledexport@gsfcarparts.com](mailto:aircooledexport@gsfcarparts.com)

**web** [www.gsfcarparts.com](http://www.gsfcarparts.com)

## how to pay

- Cheques
- Postal Orders
- Bank Draft
- Money Order.

*Make cheques payable to German Swedish & French.*

We accept all major cards –



### Delivery Charges - Mainland UK

Jiffy/Parcel up to 5 days max weight 500g from £2.50 + VAT

Express Order by 6pm 24-48 hrs Monday-Friday max weight 25kg from £7.95 + VAT

Next Day Noon Order by 6pm 24 hrs Mon-Fri from £12.00 + VAT

fax



020 8893 1699

email



[aircooled@gsfcarparts.com](mailto:aircooled@gsfcarparts.com)

web



[www.gsfcarparts.com](http://www.gsfcarparts.com)

## cash and carry

If you are making a long or special journey please phone first to check that the part you require is in stock.

We have an efficient “express” counter service, where you receive individual attention, help and advice.

If a part you require is out of stock we will do our best to obtain it for you. Counter customers can pay using cash, cheque, Switch and all major credit cards

**phone** 020 8917 3875

## terms and conditions

1. All goods remain the property of German Swedish & French until payment has been received in full.
  2. All orders should be checked immediately upon receipt. Shortages or damaged items must be reported within 24 hours.
  3. Items being returned for credit must be received within 5 days of purchase, accompanied by the relevant invoice.
  4. Electrical units cannot be returned for credit if fitted.
  5. Parts returned for credit must be in resaleable condition, in their original packaging. Items fitted cannot be refunded if correctly supplied.
  6. Surcharges must be paid on purchase of all exchange units. The surcharge will then be credited when the unit has been cleared through our returns department.
  7. Exchange units cannot be refunded if German Swedish & French consider the part to be in an unserviceable condition.
  8. Whilst every effort is made to ensure that the information contained in this catalogue is correct at the time of going to press, product improvements or price alterations may occur during the lifespan of this catalogue.
  9. The above is a condensed version of our full terms and conditions of sale. A complete version is available FOC from any one of our outlets and is also shown on the back of any sales invoice.
  10. Occasionally we may substitute with a different quality but this is rare.
- Please note:** All prices exclude VAT. During the lifetime of this brochure prices might change due to increased Material and Engery costs. All prices correct at the time of going to press December 2004. E & OE.





# mail order form

## your details

Name: \_\_\_\_\_  
 Address: \_\_\_\_\_  
 \_\_\_\_\_  
 Country: \_\_\_\_\_  
 Phone No: \_\_\_\_\_  
 Fax No: \_\_\_\_\_  
 Customer Account No. (if known): \_\_\_\_\_  
 Delivery Address (if different from above):  
 \_\_\_\_\_  
 \_\_\_\_\_

## vehicle details

Model:Year: \_\_\_\_\_  
 Chassis No. \_\_\_\_\_  
 Engine No. \_\_\_\_\_  
 Man/Auto: \_\_\_\_\_  
 Registration No. \_\_\_\_\_

## do know someone who would like our catalogue

Name: \_\_\_\_\_  
 Address: \_\_\_\_\_  
 \_\_\_\_\_  
 Phone No: \_\_\_\_\_

**we are ready to take your calls 6 days a week**

Page No.	Part No.	Part Description	Qty	Unit Price	Extended price	Back Order if not in stock yes/no

**mail order form**

## Method of payment

Personal Cheque       Postal Order

      
  /Solo      
 

Expiry Date \_\_\_\_\_ Issue No. \_\_\_\_\_  
 Signed \_\_\_\_\_ Date \_\_\_\_\_  
 Card Number 

--	--	--	--	--	--	--	--	--	--	--	--	--	--	--	--	--	--	--	--	--

Parts Total	
Carriage	
Surcharge (if any)	
VAT UK/EU 17.5%	
<b>TOTAL</b>	

Please note prices in Eire are in Euros, and therefore may differ from those in the UK



# branches nationwide

see inside for branch details

- |                                          |                                          |
|------------------------------------------|------------------------------------------|
| 01. ACCRINGTON<br>Tel: 01254 384500      | 23. LEEDS<br>Tel: 0113 2443637           |
| 02. BELFAST<br>Tel: 02890 663866         | 24. LEICESTER<br>Tel: 0116 234 0200      |
| 03. BIRMINGHAM<br>Tel: 0121 626 7970     | 25. LINCOLN<br>Tel: 01522 575333         |
| 04. BIRMINGHAM NW<br>Tel: 0121 565 6340  | 26. LIVERPOOL<br>Tel: 0151 525 1764      |
| 05. BRADFORD<br>Tel: 01274 652020        | 27. LONDON N8<br>Tel: 020 8341 7570      |
| 06. BRISTOL<br>Tel: 01179 557654         | 28. LONDON NW10<br>Tel: 020 8960 8182    |
| 07. CARDIFF<br>Tel: 029 2034 7900        | 29. LONDON SOUTH<br>Tel: 020 7274 0082   |
| 08. CHADWELL HEATH<br>Tel: 020 8598 8800 | 30. LUTON<br>Tel: 01582 506940           |
| 09. CHELMSFORD<br>Tel: 01245 460460      | 31. MANCHESTER (N)<br>Tel: 0161 727 7010 |
| 10. DAVENTRY<br>Tel: 01327 871009        | 32. MANCHESTER (S)<br>Tel: 0161 876 0466 |
| 11. DERBY<br>Tel: 01332 757494           | 33. NORWICH<br>Tel: 01603 780900         |
| 12. DUBLIN<br>Tel: 01460 6062            | 34. NOTTINGHAM<br>Tel: 01159 503723      |
| 13. EXETER<br>Tel: 01392 204321          | 35. PLYMOUTH<br>Tel: 01752 600610        |
| 14. FARNHAM<br>Tel: 01252 333891         | 36. POOLE<br>Tel: 01202 741060           |
| 15. GLASGOW<br>Tel: 0141 429 5511        | 37. PORTSMOUTH<br>Tel: 02392 325945      |
| 16. GREENFORD<br>Tel: 020 8813 3050      | 38. READING<br>Tel: 01189 873030         |
| 17. HEATHROW<br>Tel: 020 8917 3801       | 39. SHEFFIELD<br>Tel: 01142 617888       |
| 18. HEMEL HEMPSTEAD<br>Tel: 01442 248894 | 40. SOUTHAMPTON<br>Tel: 023 8086 3900    |
| 19. HITCHIN<br>Tel: 01462 454871         | 41. SWANSEA<br>Tel: 01792 704980         |
| 20. IPSWICH<br>Tel: 01473 748166         | 42. THURROCK<br>Tel: 01708 890740        |
| 21. KINGSTON<br>Tel: 020 8547 3101       | 43. WATFORD<br>Tel: 01923 229255         |
| 22. LEAMINGTON SPA<br>Tel: 01926 451980  | 44. WORTHING<br>Tel: 01903 236980        |

new branches opening soon

**GSFCAR PARTS**

